

Is Your Home Protected From Earthquake Disaster?

A Homeowner's Guide to Earthquake Retrofit



**INSTITUTE FOR
Business &
Home Safety**

Prepared by the Institute for Business & Home Safety. The Institute for Business & Home Safety (IBHS) is an initiative of the insurance industry to reduce deaths, injuries, property damage, economic losses and human suffering caused by natural disasters. IBHS is a nonprofit research and communications organization committed to institutionalizing natural disaster protection as a public value.

acknowledgments

The staff of the Institute for Business & Home Safety (IBHS) wishes to acknowledge the valuable input of all those involved in preparing this brochure. In particular, we extend our thanks to:

The IBHS Earthquake Peril Committee Members

The IBHS Public Relations Committee Members

The IBHS Retrofit Committee Members

The National Geophysical Data Center (NGDC)

Earthquake Engineering Research Center, University of California, Berkeley (EERC, UCB)

Earthquake Engineering Research Institute (EERI)

cover photo credits

EERI Northridge Earthquake Reconnaissance Team, J. Hall, CIT; F. Desler, APA; Godden Collection, EERC, UCB; and USGS, D. Perkins

architectural illustrations

W. Spaulding, AIA

disclaimer

The suggestions and recommendations you will read in this guide are based on professional judgment, experience and research. The authors, contributors and publisher disclaim all warranties and guarantees with respect to the information in the document and assume no liability or responsibility with respect to the information.

(c) 2001 Institute for Business & Home Safety
All rights reserved.
ISBN 1-885312-22-9

table of contents



introduction	1
earthquakes and your home	2
Earthquakes: What, When, Where and Why	2
Measuring an Earthquake's Size	4
What You Feel and Why You Feel It	4
What Your Home Experiences	5
What You Can Do	6
nonstructural retrofits	7
Bookcases	7
Cabinets and Drawers	10
Picture Frames and Bulletin Boards	12
Ceiling Lights, Suspended Ceilings and Hanging Fixtures	13
Windows and Doors	15
Large Appliances	15
Water Heaters	16
structural retrofits	19
Foundation Systems	21
Slab-on-Grade Foundations	21
Crawl Space and Basement Foundations	23
Post-and-pier Foundations	25
Floor Systems	27
Wall Systems	28
Wood-Framed Walls	28
Unreinforced Masonry Walls	29
Roof Systems	30
Unreinforced Chimneys	31
Garages	33
Room Additions	33
home improvement project list	34
before, during and after: be completely prepared	35
references	37
additional sources of information	38
checklist	42



F. Desler, APA



Top: Earthquake damage in Kobe, Japan.
Right: San Francisco Marina fire caused by broken gas lines.
Background: Shored building in the Marina District, San Francisco.

USGS, D. Perkins



EERI, J. Egan

introduction

Earthquakes occur suddenly with little or no warning, during any season and at any time of day.

Although the West Coast generally has the greatest earthquake activity, the potential for earthquakes exists in almost every corner of the United States. More than 3,360 Americans have died during earthquakes in the last century, and homes in all 50 states have suffered damage in the last 250 years.¹

So, what can you do to protect yourself, your home and its contents from earthquakes? This brochure will help you by providing information about:

- the relationship between your home and an earthquake;

- key areas of your home that are especially susceptible to damage;
- ways you can reduce damage to your home and belongings; and,
- what you can do to protect yourself and your family.

The information and suggestions presented in this brochure range from simple weekend tasks that require basic carpentry skills to involved projects that may require professional assistance. Before starting on any activity, make sure you are comfortable with the required skill level. If you are uncertain, contact a professional engineer, architect or building contractor.

Damage in San Francisco's Marina District.



J. Preli

¹Based on U.S. Geological Survey numbers.

earthquakes and your home

Earthquakes: What, When, Where and Why

Did you know that the ground beneath you is constantly moving? The Earth's surface is broken into many different *plates*, which float on top of the Earth's quasi-liquid mantle. Typically, one plate interacts with another by either colliding with it, sliding past it or pushing itself underneath it. These areas along which plates interact are known as geological *faults*.

As plates move over time, the edge of one plate often catches itself on another, forcing that portion of the fault to remain motionless while stress builds.

Eventually, the fault reaches a breaking point and slips suddenly, sometimes by yards or sometimes only by inches. This sudden vertical or lateral (side-ways) movement releases seismic waves, which we feel as an *earthquake*. The point where the fault first slips is located deep within the earth and is called the *hypocenter*. Directly above that, on the earth's surface, is the *epicenter*. **Figure 1** highlights the key elements of an earthquake.

In the United States, the most active faults are along the West Coast—the most famous being the San Andreas Fault system that runs through the state of California. This fault system



NOAA/NGDC

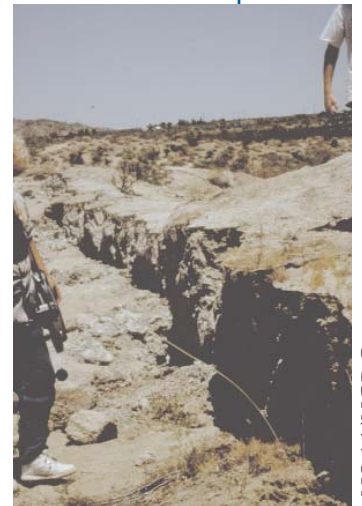

NOAA/NGDC

Figure 1: Key Elements of an Earthquake

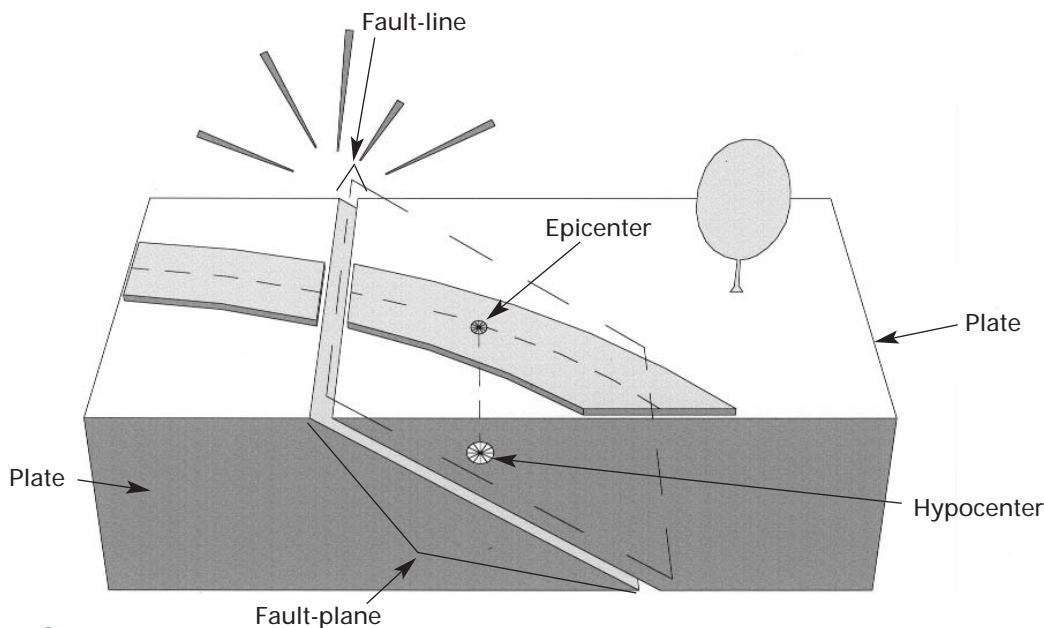

Top: The San Andreas Fault in the Carrizo Plain area, Calif.
Bottom: The fault scarp of the Landers earthquake, Calif.

separates the North American Plate from the Pacific Plate. Despite the large number of earthquakes associated with this and other plate boundaries, earthquakes are not restricted to just the plate edges. Approximately five percent of earthquakes occur within the central part of a plate. These earthquakes are known as *intraplate earthquakes*, and have occurred in recent history in Charleston, South Carolina, and the Mississippi Valley near New Madrid, Missouri.

Remember, even if you don't live in one of these areas, you are still at risk. The maps presented in **Figure 2** show where earthquakes have been recorded in the past hundred years. As you can see, no place is truly safe from earthquakes.

Figure 2: Alaskan, Hawaiian and Mainland Earthquakes

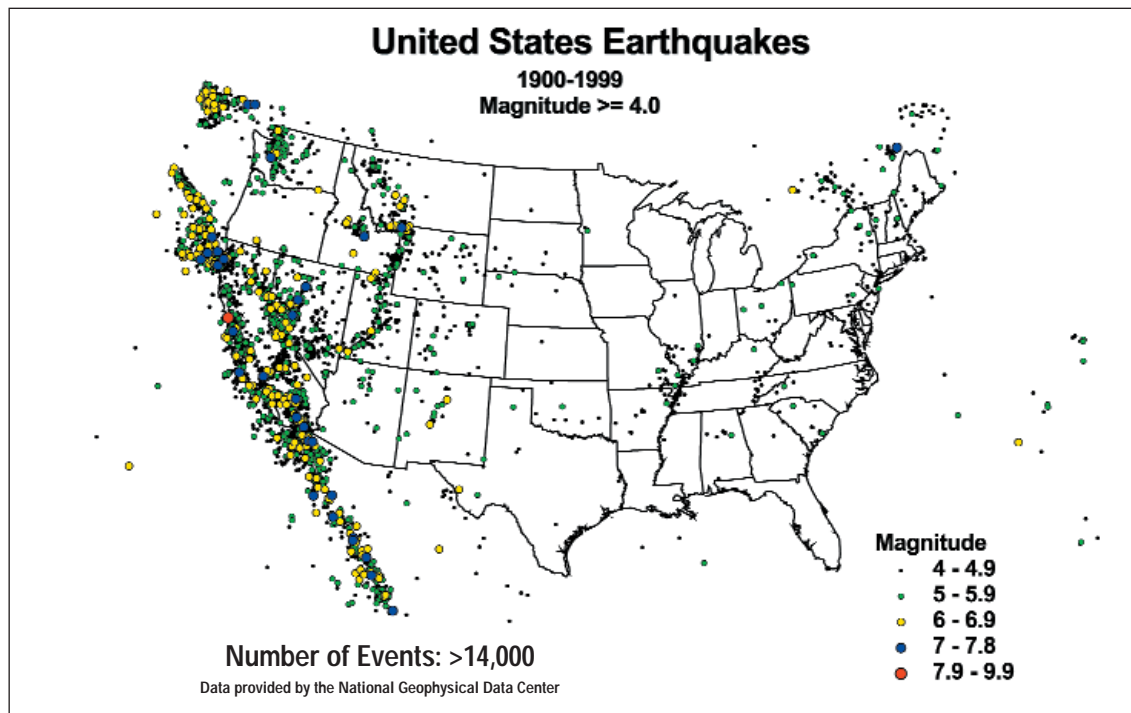
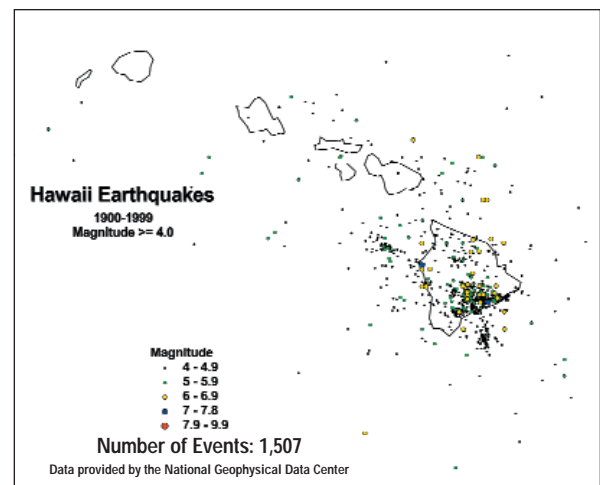
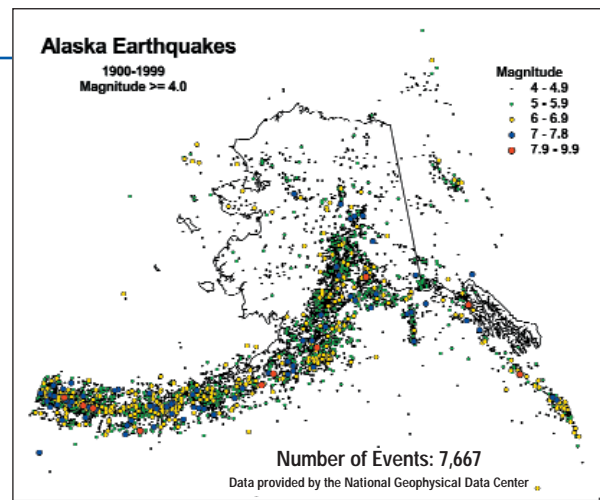

Measuring an Earthquake's Size

Seismologists estimate the size, or *magnitude*, of an earthquake in several different ways. The *Richter* scale measures the size of the earthquake's waves (amplitude); whereas, the *moment magnitude* scale estimates the total energy released during the slip of a fault. Because the moment magnitude scale is more objective than the Richter scale, it is now more commonly used. **Figure 3** shows different levels of earthquakes and their corresponding moment magnitudes (Mw).

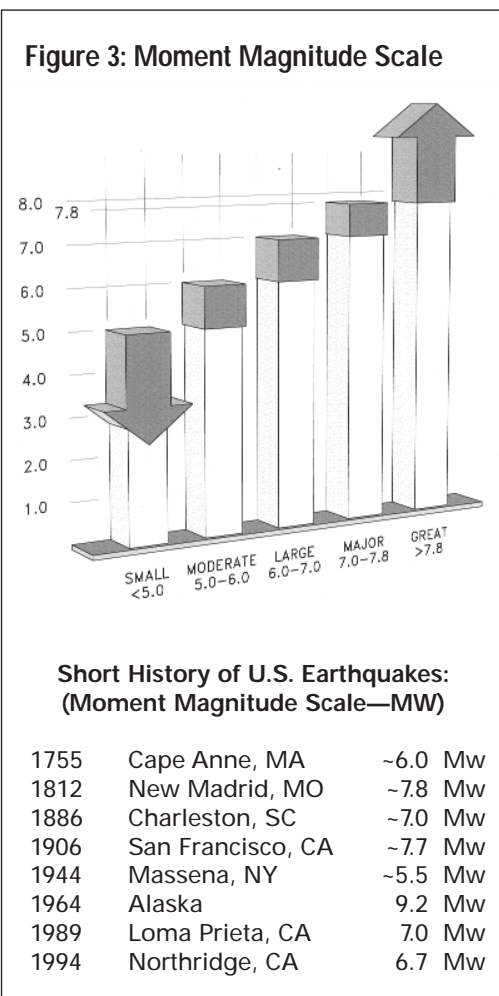

U.S. Geological Survey, C. Stover

What You Feel and Why You Feel It

The amount of movement you experience during an earthquake doesn't depend just upon its magnitude. Where you're located in relation to the earthquake's epicenter also has an effect. The farther away you are, the less shaking you feel, since the seismic waves lose energy as they travel through the earth. Imagine a drop of water hitting the surface of a pond. As the circular waves travel away from the impact, they lose energy and reduce in size and frequency. In time, they disappear altogether.

Also, the kind of soil underneath and around you plays a large role in how much of the earthquake you experience. Unlike water, soil is not uniform through-

Fissure in Santa Cruz Mountains, Calif.



NOAA/NGDC

Turnagain Heights Landslide; Anchorage, Alaska.

out. The soil type can have a dramatic effect on the way seismic waves travel through the earth. For instance softer, less compact soil can actually increase the forces. More stable soils, such as bedrock or compacted fill, dissipate an earthquake's energy more quickly.

Three major factors – an earthquake's magnitude, your proximity to the epicenter and the condition of the soil around you – determine the amount of shaking you feel. The *Modified Mercalli Intensity* scale measures this intensity by evaluating the earthquake's effect on you and your home.

What Your Home Experiences

Imagine that a strong earthquake strikes where you live. Loose items fall and break. Cabinets and bookcases tip over, blocking exits. Dust billows everywhere. Gas and water lines break, and phone and electrical service are interrupted for days. Your home may collapse, slide off its foundation or simply come apart at the seams.

Figure 4 illustrates how your home reacts in an earthquake. Because it is not able to move in sync with the surrounding ground, your home and its contents can experience substantial damage.

Figure 4: Your Home in an Earthquake

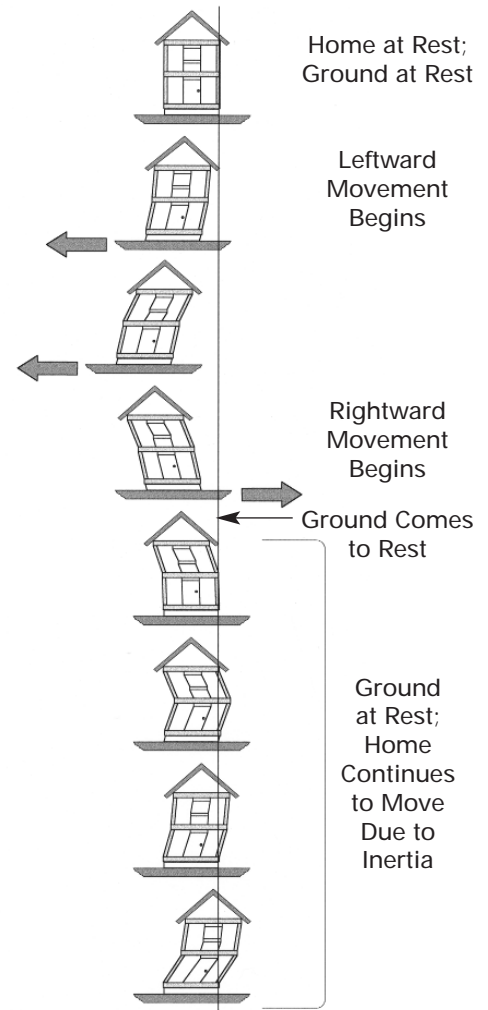

USGS, Reagor

A sand boil near El Centro, Calif. provides evidence of an earthquake.



EERI, J. Egan

Building collapse in Marina District, San Francisco, Calif.



USGS, C. Stover



NOAA/NGDC

Top: Structure shifted on its foundation in Watsonville, Calif.
Bottom: Nonstructural kitchen damage, Northridge, Calif.

What You Can Do

You can protect your home by modifying it, or retrofitting it, in two different ways:

Nonstructural retrofits protect your home's contents against damage with little cost and effort. Examples of retrofits include:

- securing water heaters, large appliances, bookcases, pictures and bulletin boards;
- latching cabinet doors; and
- using safety film on windows.

To complete these improvements simply follow the instructions in this brochure. In most cases, you won't need a building permit. It's a good idea, however, to contact your local building department to make sure.

Structural retrofits strengthen your home's structure or skeleton so it can better withstand the force of an earthquake. Your home's structure is made up of many different parts, or *components*, which must work together in order to resist an earthquake.

Modifications to your home's structure tend to be quite involved and generally require the expertise of a registered design professional (engineer, architect or building contractor) and your local building department's approval. Use this brochure to identify potential problem areas in your own home. If you have any questions or concerns about what you see, contact a professional engineer or architect.

nonstructural retrofits

In this section, you will learn inexpensive and easy ways to protect yourself against some of the damage earthquakes can cause inside your home. Start by looking for objects that could fall and break during an earthquake. Consider items such as water heaters, bookcases and light fixtures, as well as items that are difficult to replace because they have monetary or sentimental value. As you conduct your inspection, think about ways in which you can protect them from damage. If you have any questions about the changes you should make, contact a professional engineer, architect or contractor.

Bookcases

It's true that bookcases are great for storing books, toys and supplies. They can, however, shake and tip over in an earthquake, causing considerable damage or injury. For this reason, make sure all bookcases are securely fastened to nearby walls.

➤ One way to do this is to attach either L-brackets or Z-brackets to the bookcase and the wall after pre-drilling holes in each. Be sure to use a bracket that can accommodate the fasteners you are using. See **Figure 5** on page 8 for details.



Fallen bookcases at the Lawrence Livermore Lab, Livermore, Calif.

USGS

Figure 5: Securing Bookcases

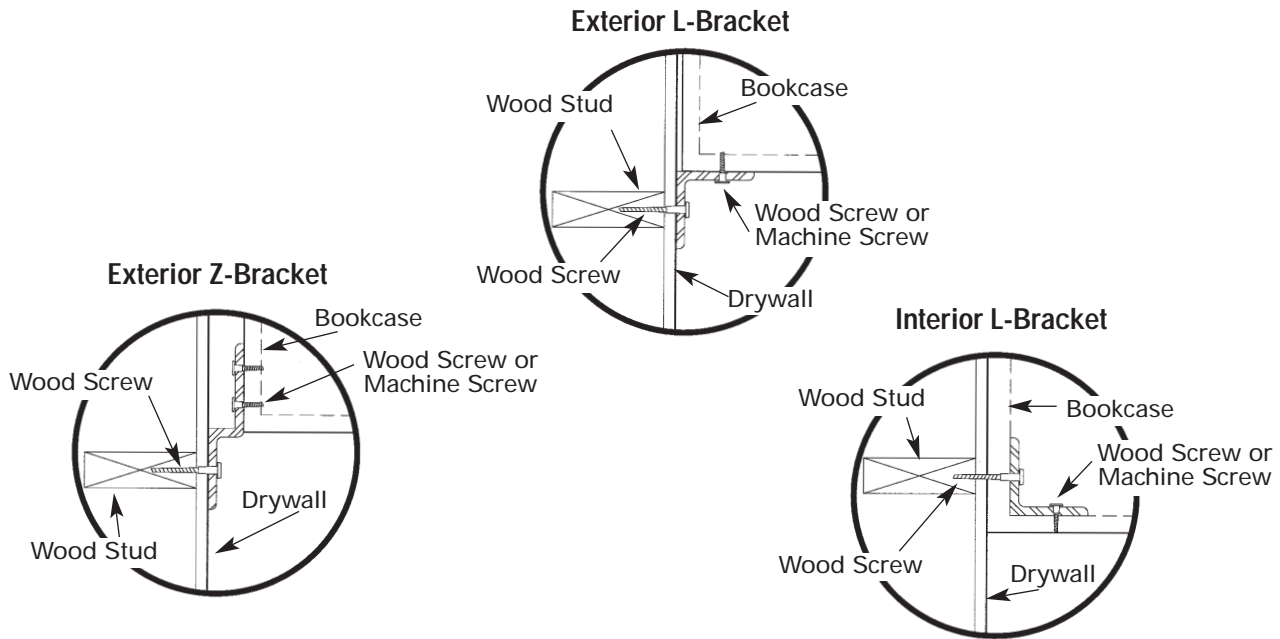

General Notes:

- Bracket to Bookcase (Interior or Exterior)
#8 (or larger) wood screws; or
#8 (or larger) machine screws with washers and nuts
- Bracket to Wall (Interior or Exterior)
Wood-stud wall: 3" long, #8 (or larger) wood screws
Masonry wall: 3" long, #8 (or larger) screws with plastic anchors, or 3/16" diameter (or larger) masonry screws

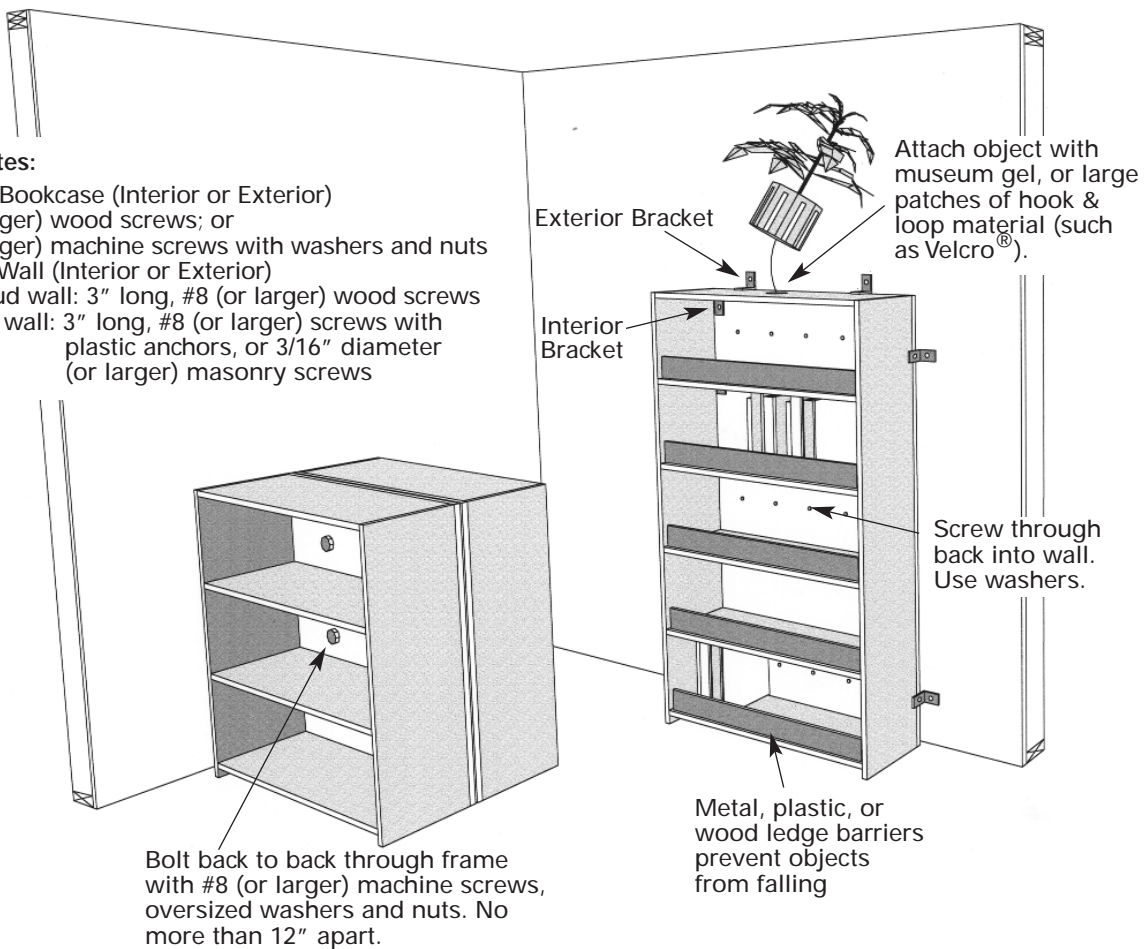

Attaching the bracket to the bookcase:

- For wood bookcases, attach the bracket with #8 (or larger) wood screws. The screw should be long enough to secure the bracket to the shelf without punching through and creating a sharp edge.
- For plastic and metal bookcases, use #8 (or larger) machine screws with washers and nuts to ensure that the bracket will stay in place. The screw should be long enough to accommodate the bracket, shelf, washer and nut.

Attaching the bracket to the walls:

- For wood stud walls, use 3-inch long #8 (or larger) wood screws to attach each bracket to the wall. Place screws in the wood studs to assure that they are properly supported. Use a stud locator to find the best places.
 - For stone or masonry walls, place plastic anchors in the holes before you screw in 3-inch long #8 (or larger) screws or consider using 3/16-inch diameter (or larger) masonry screws.
- For a bookcase with a solid back, you can pass screws directly through the back into the wall. Use washers to spread contact over a larger area between the screw and the bookcase's back. If you are working with a wood stud wall, use a stud locator to find the best locations for the 3-inch long #8 (or larger) wood screws. For a stone or masonry wall, use plastic anchors with the #8 (or larger) screws or use 3/16-inch diameter (or larger) masonry screws.

➤ You can prevent items on shelves from falling by installing ledge barriers made from strips of wood, metal or plastic. Cut them to fit the shelf and attach them with glue or mechanical fasteners. You can finish the barriers to match the shelves. See **Figure 5** for details.

➤ Place heavy items on lower shelves.

➤ You can stabilize bookcases that are not against walls by attaching them back-to-back with #8 (or larger) machine screws, oversize washers and nuts. See **Figure 5**.

➤ Affix large, heavy items, such as plants and aquariums, and other breakables directly to the shelf to keep them from falling. You can apply hook and loop material (such as Velcro®) or museum gel (or museum wax) to secure these items. For added protection, use metal, plastic or wood ledge barriers. See **Figure 5** for details.

Necessary Tools and Materials

- L- or Z-brackets
- Fasteners
- Plastic anchors for masonry walls
- Variable speed drill and bits
- Screwdriver
- Stud locator
- Wood, plastic or metal strips
- Paint or wood finish
- Hook and loop material (Velcro®) or museum gel/wax



Cabinets and Drawers

Like bookcases, cabinets can tip over and their doors can open, spilling their contents. Furthermore, the drawers, which sometimes have sharp edges, can slide out and hurt you, or your family.

- To secure them, do the following:
 - Attach cabinets to the wall and floors using L-brackets or Z-brackets. Again, be sure to use brackets that can accommodate the diameter of the fasteners. You should follow the specific directions given in **Figure 6** and in the “Bookcases” section for securing the bracket to the wall and cabinet.



EERI Coalinga Earthquake Reconnaissance Team, S. Ribal, Cal. Poly.

Interior damage to kitchen, Coalinga Junior High School, Coalinga, Calif.

Figure 6: Cabinets and Drawers

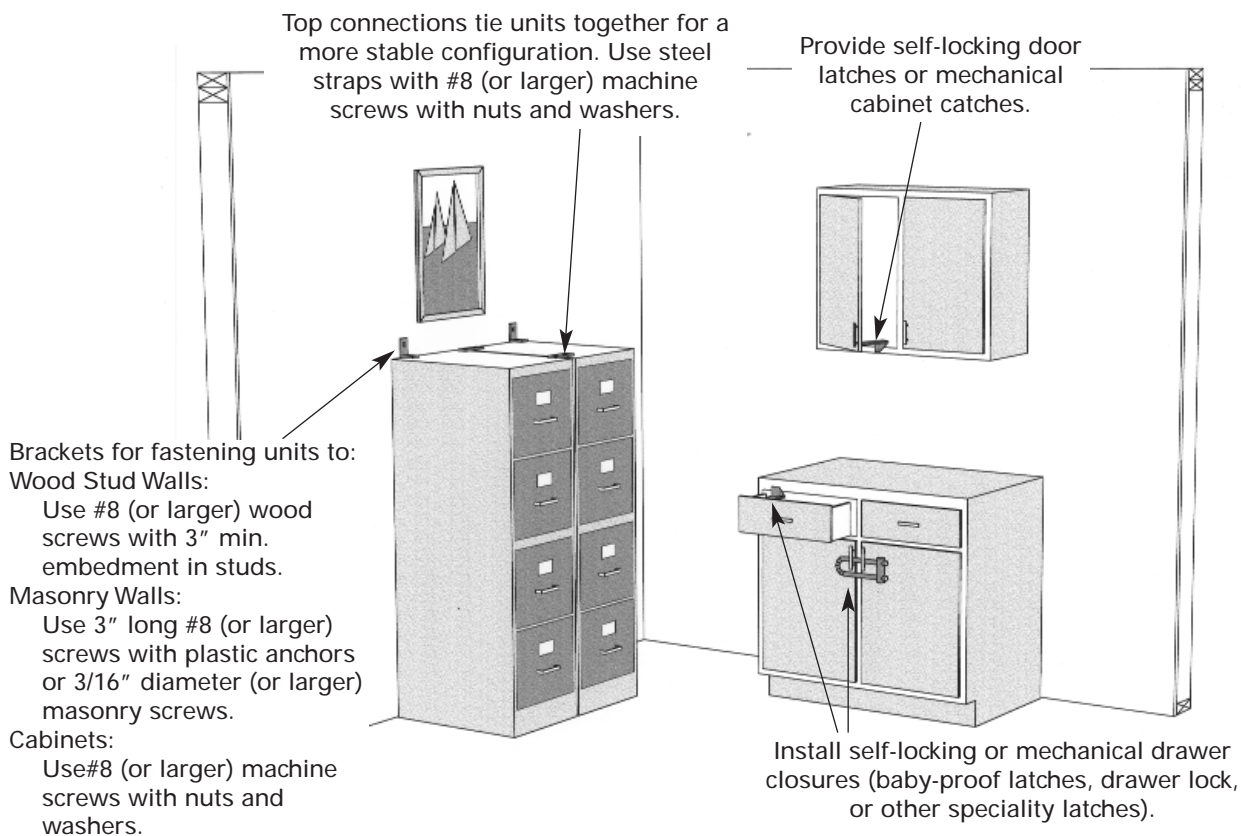

- You can fasten several units together to form a wider footprint using #8 (or larger) machine screws.

- Attach simple mechanical or self-locking latches to cabinet drawers so they cannot slide open.
- Install mechanical or self-locking latches to prevent your cabinet doors from swinging open and spilling their contents. Your local hardware store has a large variety of latches, many of which are small, unobtrusive and easy to operate. See **Figure 6** for details.
- Most of us place heavy objects such as televisions, computers and stereos on top of cabinets, bookcases and tables. You should fasten these items down so they will not slide off during an earthquake. Several methods of attachment are shown in **Figure 7**.

Figure 7: Secure Heavy Objects

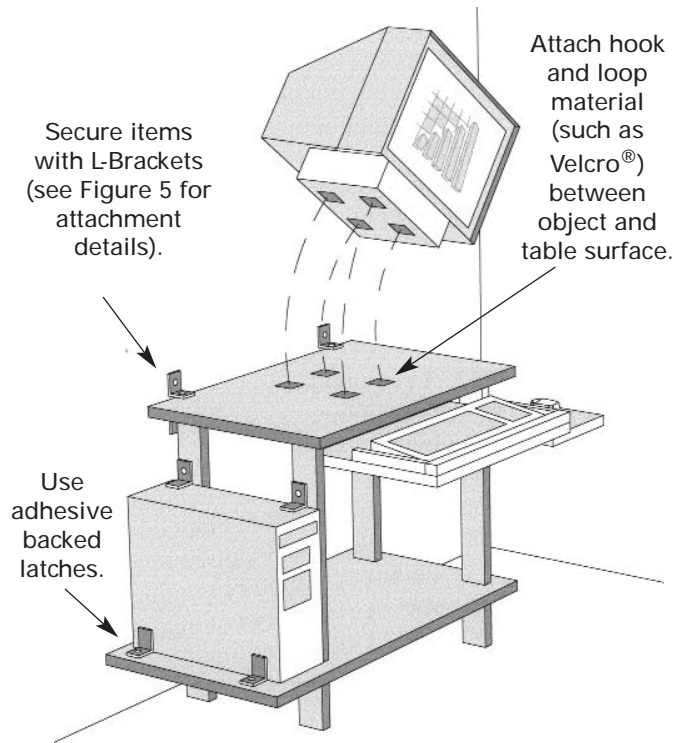



Necessary Tools and Materials

- L- or Z-brackets
- Fasteners
- Door or drawer latches
- Plastic anchors for masonry walls
- Variable speed drill and bits
- Screwdriver
- Stud locator



J. Preli

Damage to framed pictures, Northridge, Calif.

Picture Frames and Bulletin Boards

The photographs, bulletin boards and artwork you display in your home add to its character. But these items can easily fall during an earthquake if you do not fasten them properly to a wall in the following way:

- Use closed screw-eyes, instead of traditional picture hangers, for securing picture frames, bulletin boards and mirrors.
 - Depending on the weight of the object and the screw-eye's maximum weight limit, screw one or more closed screw eyes into wall studs. Use a stud finder to figure out where to put them.
 - Attach picture wire to one side of the frame. Thread the wire through the closed screw-eye, fastening it securely to the other side of the frame. See **Figure 8**.
 - If you use an open screw-eye instead of a closed screw-eye, be sure to close it with pliers once you have hung the picture.
- Always mount heavy or sharp wall hangings away from areas where they could fall on children.

Necessary Tools and Materials

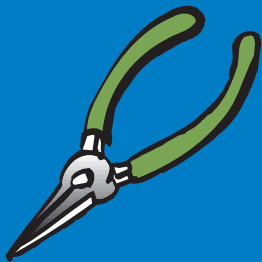

- Stud locator
- Screwdriver
- Variable speed drill and bits
- Screw-eyes
- Heavy picture wire
- Pliers

Figure 8: Secure Picture Frame to Wall

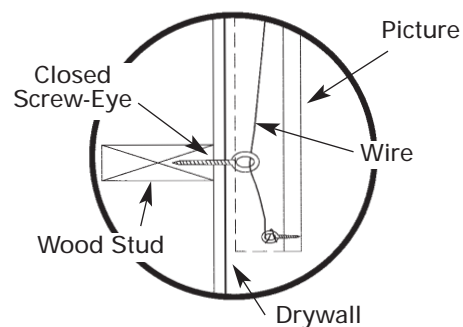

Ceiling Lights, Suspended Ceilings and Hanging Fixtures

If they aren't well attached and supported, ceiling lights, suspended ceilings and hanging fixtures, such as chandeliers and ceiling fans, can fall in an earthquake and seriously injure those below. Here are some ways to protect yourself:

➤ Secure ceiling lights to supports using safety cables.

- Use a chain strap or a minimum 14-gauge wire to attach the light fixture to a nearby ceiling support. Locate the support visually or use a stud locator. Be sure to leave the safety cables slack; they should not support the weight of the lights under normal circumstances. See **Figure 9** for details.
- If your ceiling light has a cover, keep it from falling during an earthquake by fastening it to the fixture itself or to the home's permanent structure.
- Pay special attention to your home's fluorescent lights. Installing plastic sleeves over the fluorescent light tubes will keep the glass from scattering if they break. As an alternative, consider using Teflon[®] fluorescent lights, which are shatter-resistant.

➤ Use safety cables every few feet to attach suspended or false ceilings to the structure of your home.

- Use chain straps, plumber's strapping (metal strapping with holes) or heavy wire (minimum 14-gauge) to secure suspended or false ceilings. See **Figure 9**.



*EERI Coalinga Earthquake Reconnaissance Team
S. Ribbat, Cal. Poly.*



EERI, S. Swan, EQE Inter.

Top: Failure of pendant light fixtures in the Dawson Elementary School library, Coalinga, Calif.

Bottom: Damage to suspended ceiling and recessed ceiling lights, Philippines.

- Use screws, bolts or other appropriate fasteners to attach the safety cables to both the suspended ceiling and the permanent structure.
- You can prevent the ceiling panels from flying upward by installing adjustable compression struts. Contact your suspended ceiling manufacturer for details. See **Figure 9**.

Figure 9: Secure Lights and Suspended Ceilings

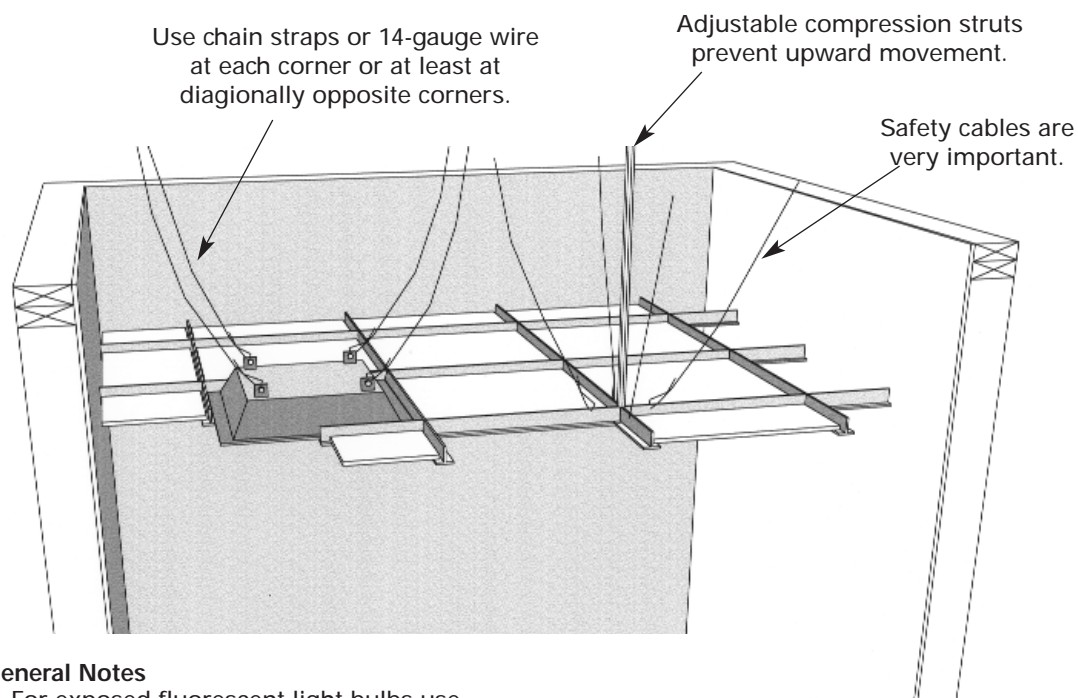

General Notes

- For exposed fluorescent light bulbs use protective sleeves.
- Secure light covers in place.
- To secure a wire or chain, use a minimum of 3 tight turns in 1-1/2" at each end.

Necessary Tools and Materials

- Safety cables, chain straps, heavy wire or plumber's strapping
- Fasteners
- Adjustable compression struts
- Screwdriver
- Variable speed drill and bits
- Stud locator
- Plastic sleeves for fluorescent lights
- Light covers

➤ Make sure chandeliers, ceiling fans, other suspended fixtures and hanging plants are safely secured to the permanent structure.

- Connect all suspended items to strong supports with safety cables capable of supporting each item's entire weight. Each cable should remain slack and not support the item's weight under normal circumstances.
- Keep in mind that hanging items tend to sway easily. Make sure these objects will not collide with anything if they swing in an earthquake.

Windows and Doors

Your home's windows and glass doors may seem harmless enough. But in an earthquake, glass can break explosively, seriously injuring anyone nearby. One way to protect yourself and your family from broken glass is to apply safety film to windows and glass doors:

- Use a protective film (minimum thickness of 4 mils) on all types of glass, including tempered glass and annealed glass. You can buy it in rolls at your local hardware and home improvement stores, or contact the International Window Film Association for the nearest distributor. Be sure to install the film according to the manufacturer's instructions.
- As an alternative, consider professional installation.

Large Appliances

An earthquake can cause refrigerators, washing machines and other large appliances to slide or fall over. Heavy objects on wheels may roll if brakes or stops are not provided and locked. To secure these items:

- Anchor large appliances to walls using safety cables or straps. The restraint should be located in the mid- to upper-portion of the appliance. Use the following method:
 - Choose a screw-eye that is sized appropriately for the appliance. For example, use a 3/8-inch diameter screw-eye (or larger) for a refrigerator.
 - For wood stud walls, use a stud locator to find the best wall location to install the screw-eye. For stone or masonry



Damaged building, Coalinga, Calif.

USGS, M. Hopper

walls, place plastic anchors in the pre-drilled holes before you install the screw-eye.

- Connect coated wire cable to the screw-eye at one end and to a snap-hook fastener at the other end.
 - Attach the cable to the appliance with the snap-hook fastener.
- Replace rigid water or gas connections on large appliances with flexible connectors.
 - Check to see if your local building codes allow you to use flexible connectors and whether a professional must install them.
 - Always lock the rollers of any large appliances or pieces of furniture.

Necessary Tools and Materials

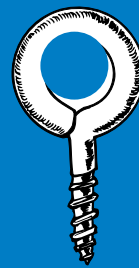

- Coated wire cable or other strapping system
- Screwdriver
- Variable speed drill and bits
- Stud locator
- Screw-eyes
- Hook fasteners
- Flexible connectors
- Plastic anchors



Ben Rothholz

Water heater burned in residential fire caused by a gas leak.

Water Heaters

Water heaters can move or tip over in an earthquake and the broken water pipe can flood your home, destroying ceilings, floors, walls, furniture, artwork and family photos. If your heater runs on flammable gas and the gas line breaks, the situation becomes far more serious.

In many areas of the country where earthquakes are common, local building codes may require that water heaters be laterally braced or strapped to resist seismic forces. Most hardware stores sell retrofit kits for different-sized water heaters. In addition, several generic restraint systems are available. **Before you decide on a retrofit method, check with your local building department and make sure that it is approved for use in your area or goes beyond what is required by your local building code.**

Figure 10: Retrofitted Water Heater

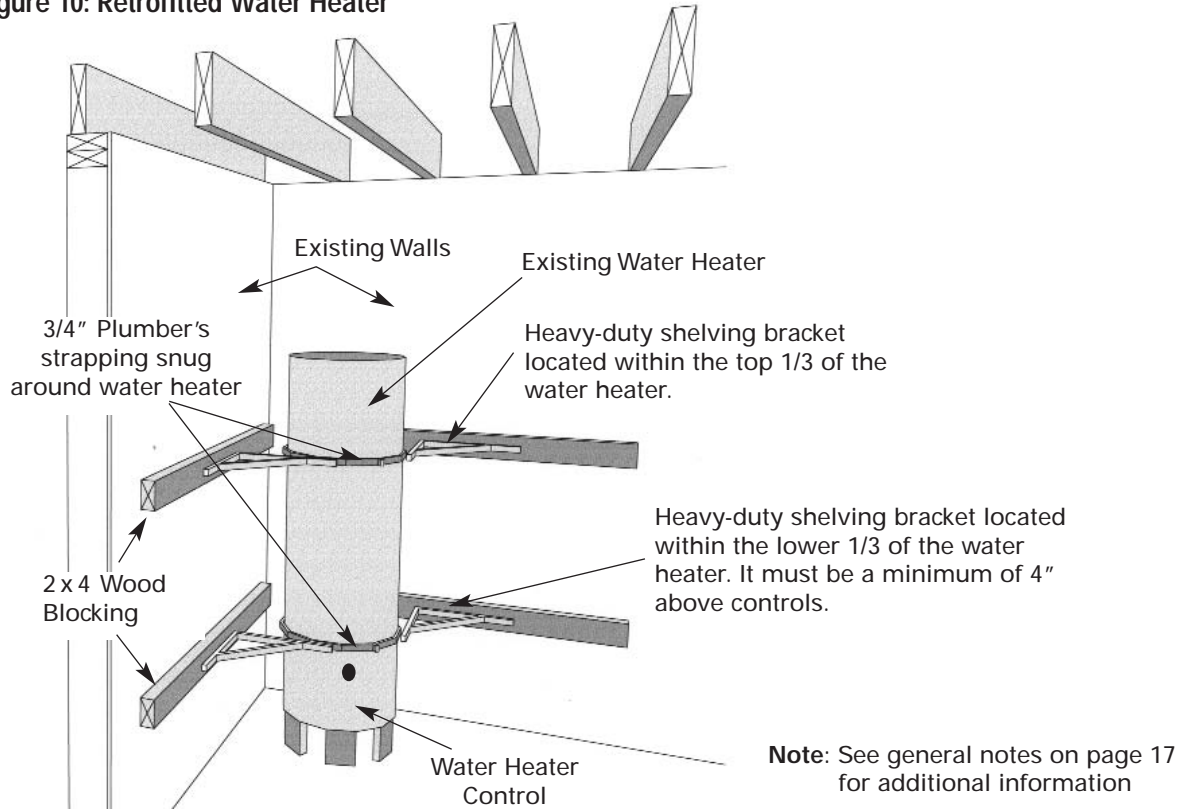
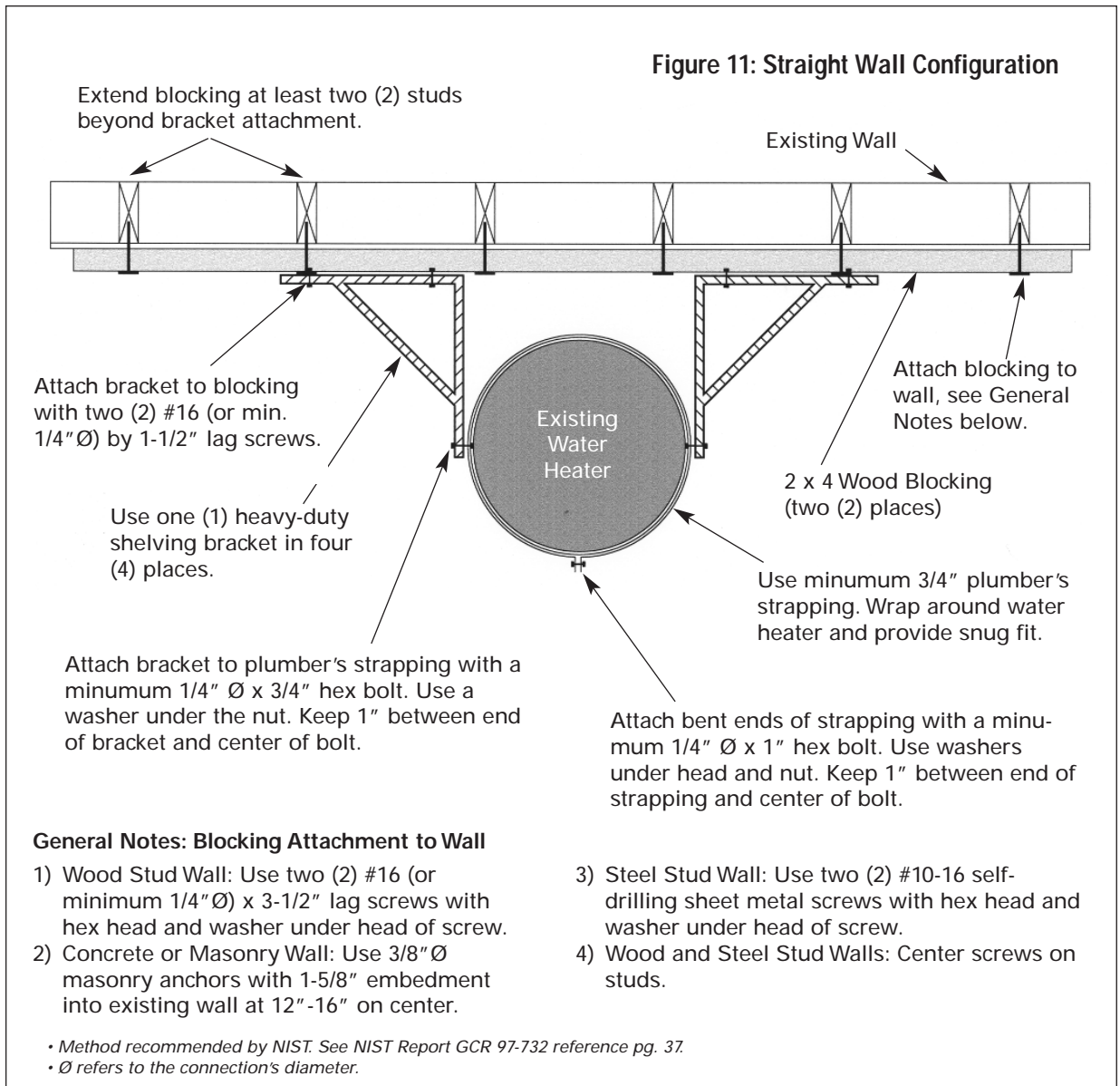

Figure 11: Straight Wall Configuration



➤ Secure water heaters (up to 50 gallons) to stud walls using the simple, generic method detailed in **Figures 10 through 12**.

- You can anchor the water heater using items that are readily available from the local hardware store.
- To begin: fasten two 2 x 4 wood blocking strips to the nearby wall - one at a

height within the upper one-third (1/3) of the water heater and the other within the lower one-third (1/3) of the water heater. The lower 2 x 4 should be at least four (4) inches above the water heater control. If you are working with a wood or metal stud wall, attach the blocking directly to the studs. Use a stud locator to find the studs.

Figure 12: Corner Wall Configuration

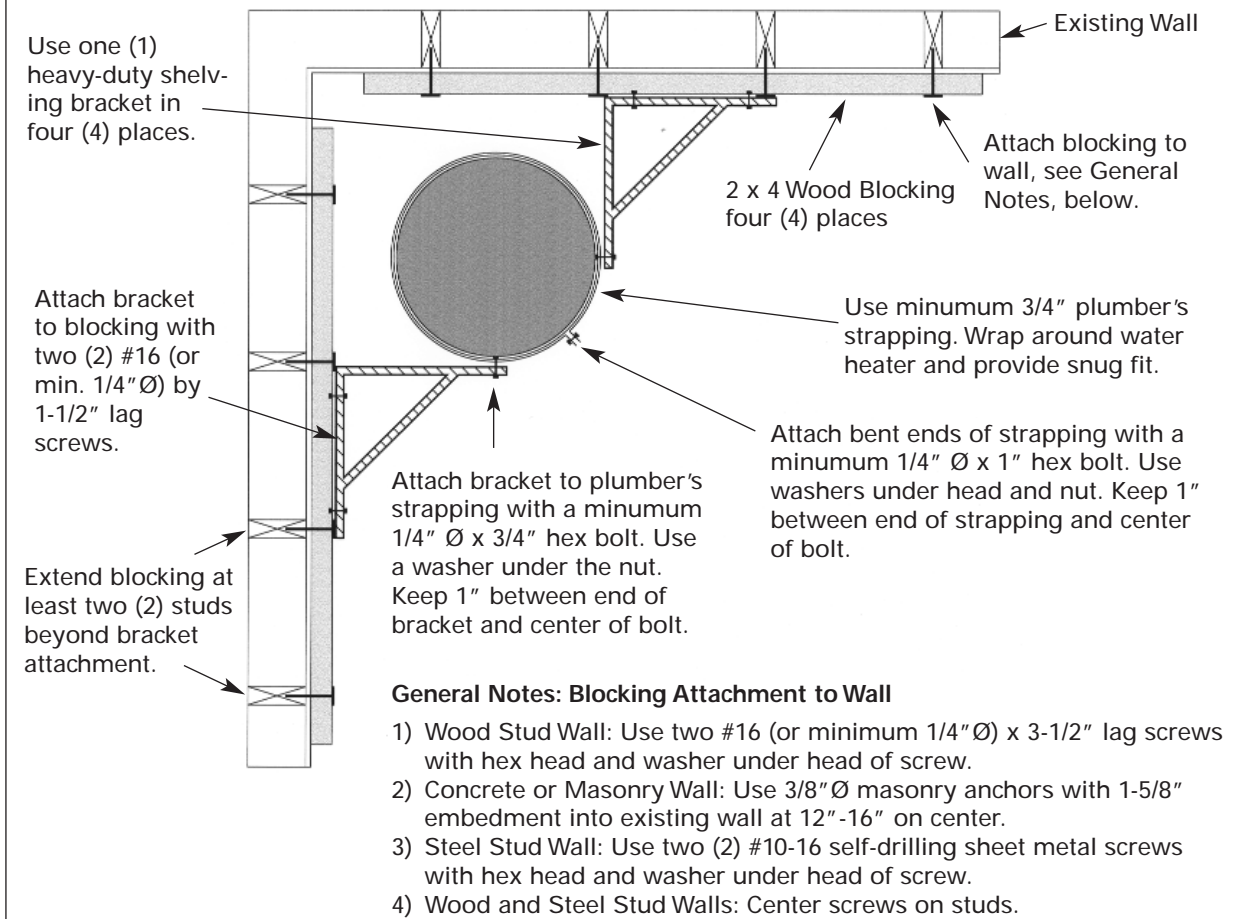

General Notes: Blocking Attachment to Wall

- 1) Wood Stud Wall: Use two #16 (or minimum 1/4"Ø) x 3-1/2" lag screws with hex head and washer under head of screw.
- 2) Concrete or Masonry Wall: Use 3/8"Ø masonry anchors with 1-5/8" embedment into existing wall at 12"-16" on center.
- 3) Steel Stud Wall: Use two (2) #10-16 self-drilling sheet metal screws with hex head and washer under head of screw.
- 4) Wood and Steel Stud Walls: Center screws on studs.

• Method recommended by NIST. See NIST Report GCR 97-732 reference pg. 37.
 • Ø refers to the connection's diameter.

Necessary Tools and Materials

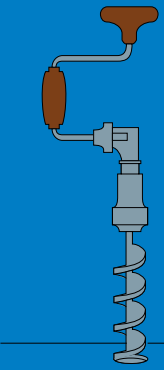

- 2 x 4s
- Stud locator
- Screwdriver
- Hammer drill & bits (stone & masonry walls)
- Variable speed drill & bits (wood & metal stud walls)
- Various fasteners
- Heavy-duty shelving brackets
- Plumber's strapping
- Flexible connector

- Fasten heavy-duty shelving brackets to the wood blocking. These brackets should fit snugly against the water heater.
- Wrap plumber's strapping (metal strapping with holes) around the heater and secure it to the brackets.
- Remember: Use flexible, not rigid, water and gas connectors and check with local building code officials to see if you must hire a licensed plumber to modify the connections.
- Make certain all adult and teenage family members know where to locate the gas shut-off valve and how to operate it.

structural retrofits

When an earthquake strikes, your home's structure is put to the test. The skeleton must absorb the earthquake's energy and provide a stable path to transfer the forces back into the ground. For this to happen, your home's structure must be *tied together*; that is, your home's roof should be tightly attached to the walls, and your walls should be fastened to each other, braced and anchored to a strong foundation. **Figure 13** on page 20 shows how the components of a home can be secured to each other, so that they function as a single unit during an earthquake.

Keep in mind that the purpose of this section is to help you identify key areas of your home's structure that are

susceptible to earthquake damage. If you are uncertain about what you see, or if you decide to have work done, enlist the help of a professional architect, engineer, building contractor or your local building department.

Remember that an ideal time to inspect and retrofit your home's structure is when you are making a significant change to your home such as adding on a room or remodeling. In either case, it is important that your work conforms to local building code requirements. Although the existing portion of your home may not need to be upgraded to current code requirements, now may be a good time to do so. Contact your local building code official to find out what is required for your project.

Cripple wall
foundation failure,
Northridge, Calif.



J. Prelli

Figure 13: Typical Wood Frame House

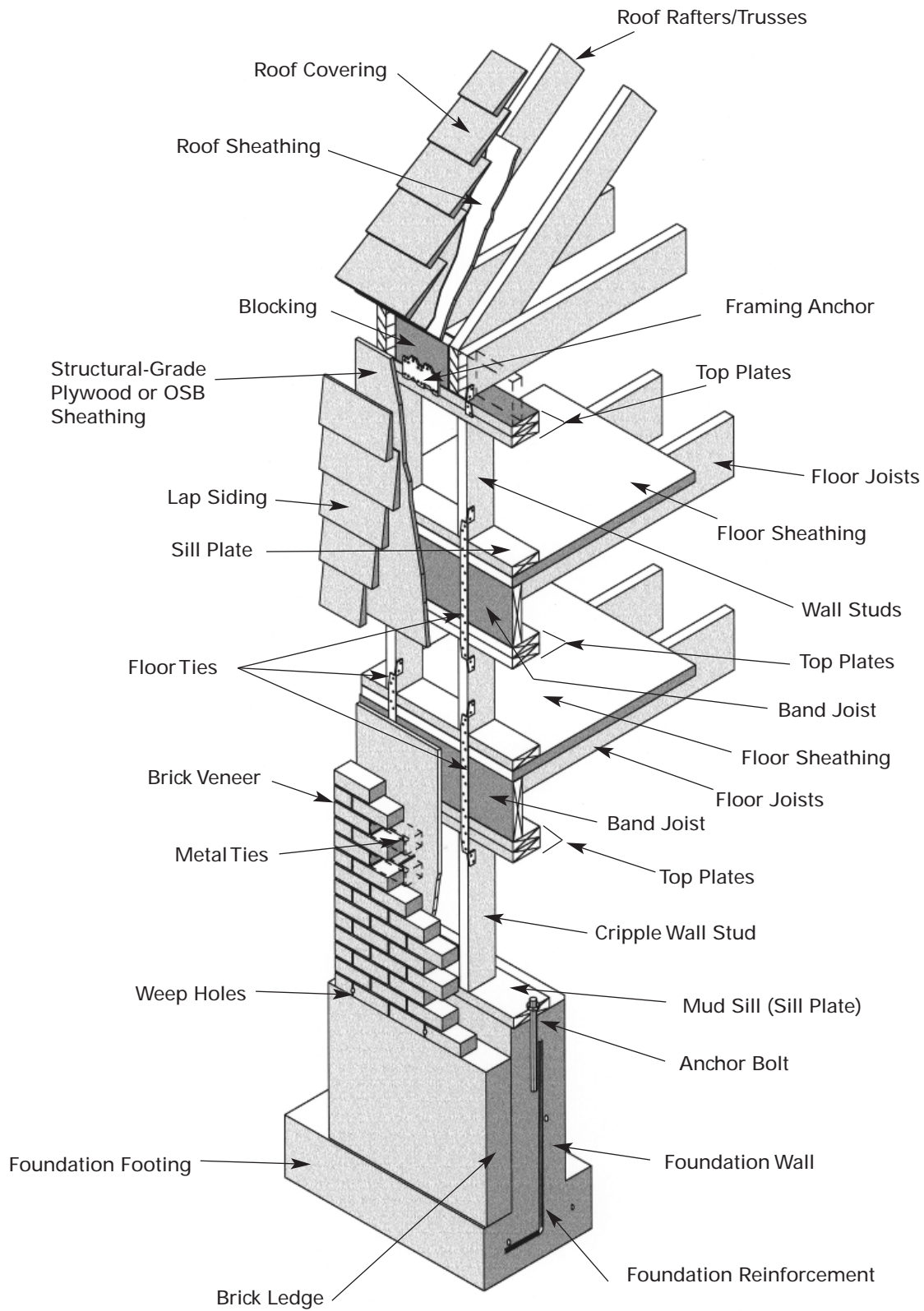

Foundation Systems

Earthquakes can create ground motion in any direction. During a quake, your home's foundation moves with the earth, but the rest of your home reacts more slowly due to its inertia. See **Figure 4** on page 5. This creates a tremendous amount of stress on the connections between the foundation and the remaining structure. If these connections are not strong enough, your home may slide or fall off its foundation. In fact, this is one of the most common and costly types of structural damage. Depending upon the foundation, however, this may be relatively easy to fix.

SLAB-ON-GRADE FOUNDATIONS

Slab-on-grade foundations are just that: concrete slabs that rest on the ground. In an earthquake-prone area, a home's wood-frame structure should be connected to the slab with either *anchor bolts* or other *steel connectors* (including steel plates). **Figure 14** on page 22 illustrates both types of connections.

If your home has anchor bolts, it can be difficult to conduct a thorough inspection, since you must get access to the top of the *sill plate*. This almost always requires that you remove an inside or outside finished wall, so consider doing this when remodeling your house. Your inspection should reveal minimum 1/2-inch-diameter anchor bolts with washers and tightened nuts connecting the sill plate to the foundation. These bolts should be spaced no more than six feet apart. Make sure that the bolts are in good condition and show no rust and that the nuts are tight. The concrete surrounding the bolt should be strong and free of any severe cracks (wider than the edge of a dime).



L. Brewer, USGS



Steinbrugge Collection
EERC, UCB

Top: Separation of porch from rest of house due to unanchored foundation, Petrolia, Calif.

Bottom: Home has shifted off its unanchored slab-on-grade foundation, Coalinga, Calif.

Steel plates connect the home's sill plate to the foundation. Carefully inspect the plates along the outside perimeter of the structure. This may require removing the exterior cladding. Both the plates and fasteners should be in good condition. Keep an eye out for rust or signs of poor workmanship. The plates should be no more than six feet apart. Next, take a close look at the foundation. Are there severe cracks (wider than the edge of a dime) in the concrete? There shouldn't be.

If the foundation is in poor condition or you must add additional anchorage, ask a professional engineer for help.



J. Preli

Cripple wall foundation failure and utility damage, Northridge, Calif.

Figure 14: Concrete Slab-on-Grade Foundation

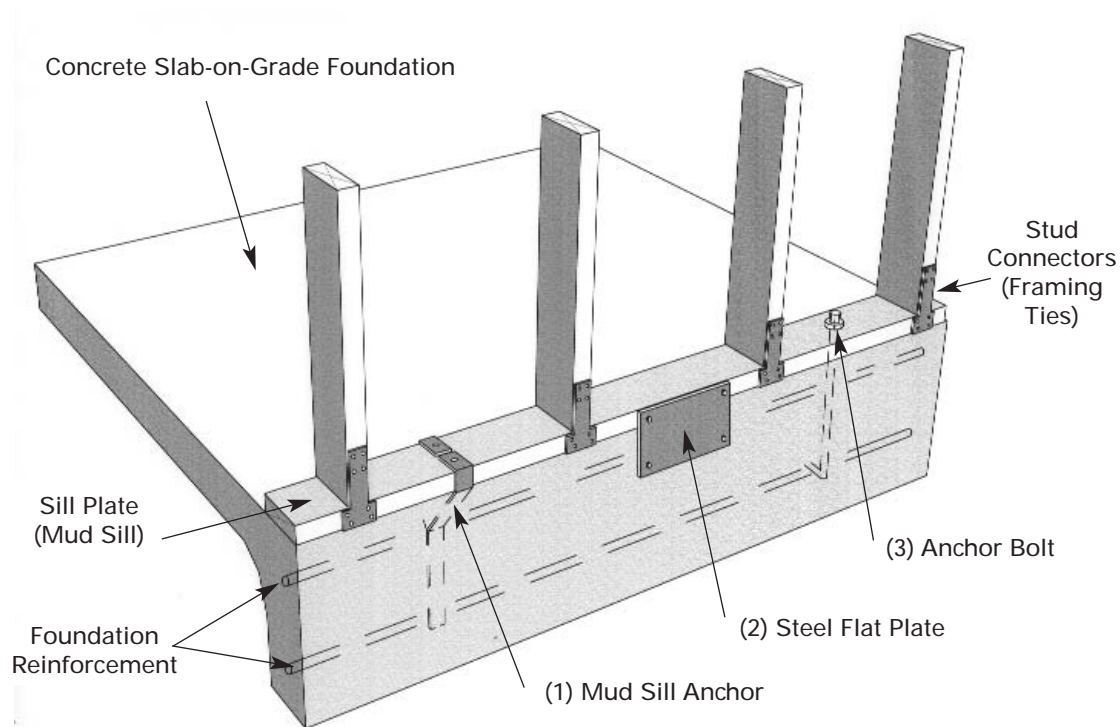

Note: Three different methods of hold-down are presented here. However, only one system is usually required.

CRAWL SPACE AND BASEMENT FOUNDATIONS

A foundation with a *crawl space* or *basement* typically has enough room underneath the first floor so that you can inspect the foundation and the underside of the floor-framing members, or *joists*, as long as the space is unfinished. The main difference between a crawl space and a full basement is the amount of headroom available.

The walls that rise from the foundation footings to the first floor are called *foundation walls*. They are typically made with masonry blocks or concrete. In some cases, a short wood stud wall, or *cripple wall*, is positioned above ground between the top of the concrete or masonry foundation wall and the first floor. Cross sections of the three basic types of wall systems are highlighted in **Figure 15**.



R. Shackelford, R. Chapman

Cripple wall foundation failure, Northridge, Calif.

Figure 15: Three Types of Foundation Walls

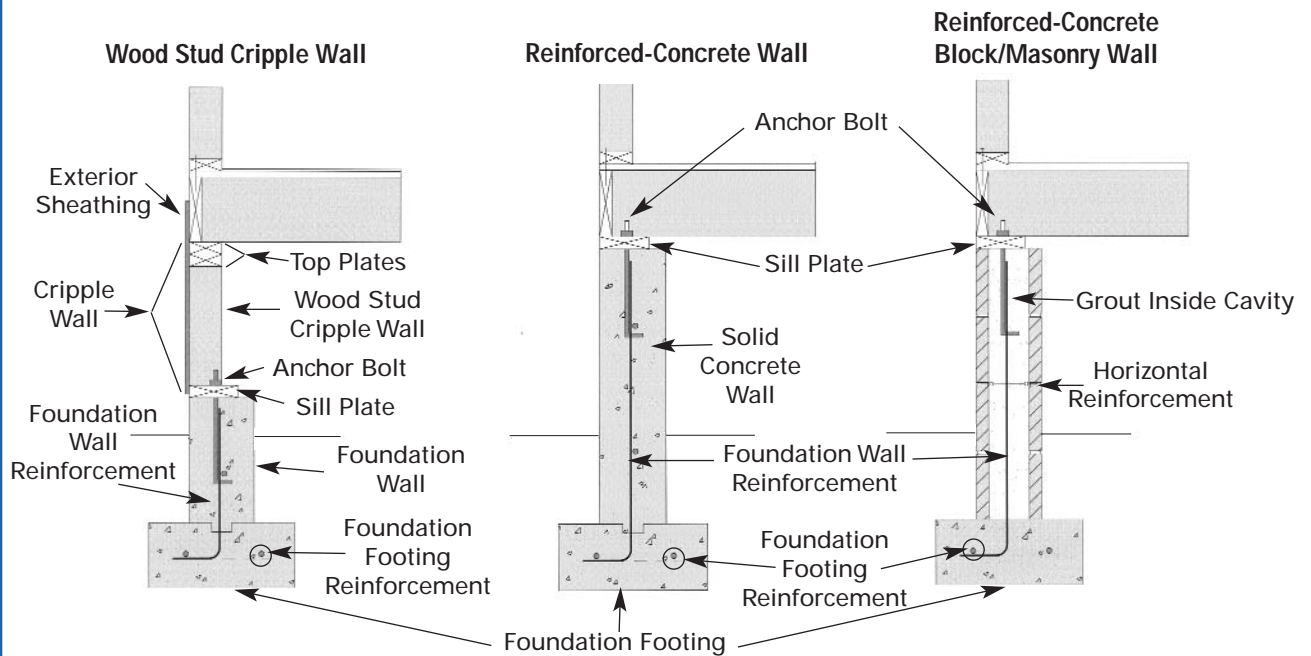

Connections

- Steel plates or minimum 1/2-inch-diameter anchor bolts should connect the wood-framing sill plate to the concrete or masonry wall. These connections should be spaced no more than six feet apart. All components should be undamaged and rust-free. Also, examine the overall condition of the foundation wall. Make sure you don't see any severe cracks (wider than the edge of a dime) in the masonry or concrete. If a wood cripple wall is present, it should show no evidence of termites or rot.
- If the foundation wall needs repair, or you need to add additional anchorage, check with a professional engineer for a suitable retrofit method.

Bracing

- For cripple walls, exterior lap siding alone cannot adequately resist the earthquake's lateral forces. You may need to add interior bracing, if it is not already there, to

prevent the cripple wall from collapsing in an earthquake:

- Nail 3/8-inch minimum structural-grade plywood or oriented strand board (OSB) sheathing to the inside of the wall. Ideally, the entire wall length should be covered. However, if you have limited access, place sheathing in each corner of your home. While the sheathing panels can be oriented in any direction, take care to ensure that each edge is supported by a stud or solid blocking.² **Figure 16** illustrates this method. If you have any questions about bracing weak cripple walls, contact a professional engineer.
- Adequately reinforced concrete foundation walls do not typically require additional bracing. Masonry foundation walls, however, may benefit from an upgrade. Because of the difficulty in evaluating masonry walls, consult a professional engineer.

² For design details, see APA's *Earthquake Safeguards* referenced on pg. 37.

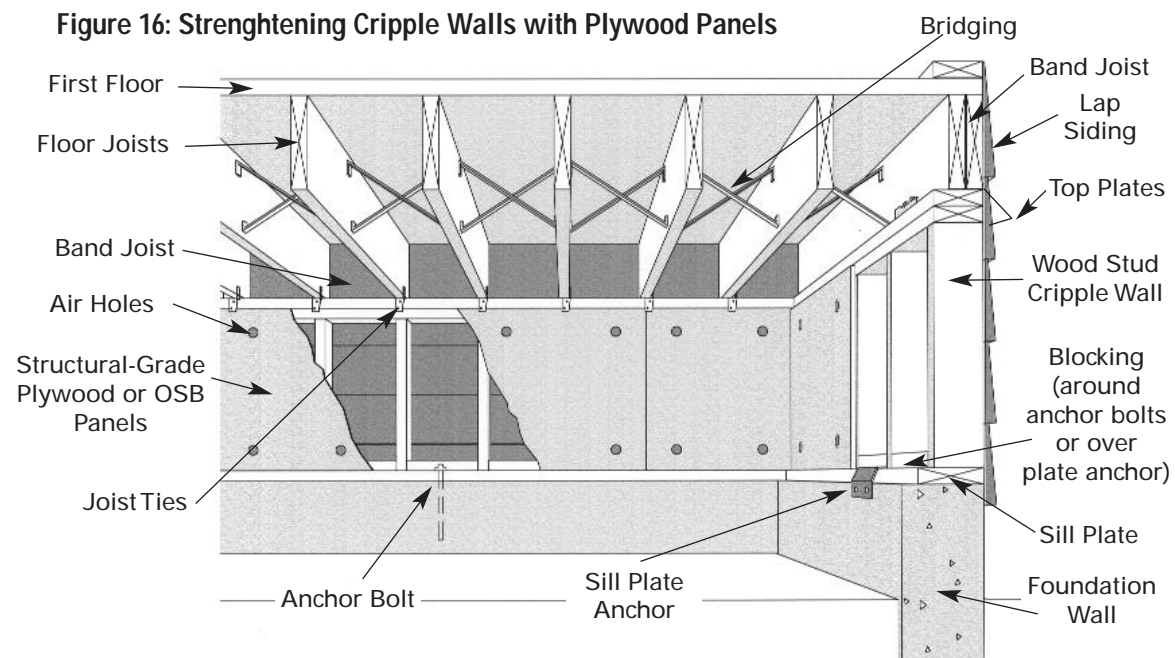

POST-AND-PIER FOUNDATIONS

A home can also be supported by a *post-and-pier* foundation (Figure 17). Large *beams* run under the home's floor *joists* and are held up by *posts*. Each post rests on a separate concrete footing or *pier*. Some post-and-pier foundations are hidden from view by a cripple wall that runs around the home's outside perimeter. This type of foundation is very susceptible to collapse during an earthquake. To better resist seismic forces, all of the foundation's components, including the beams, posts and piers, must be securely tied together.

When inspecting the foundation for possible problems, carefully examine the way the components are anchored together. The connection between the beam and the post should be strong and without rust, rot or evidence of poor workmanship. One way to help your home better withstand an



L. Brewer, USGS

Post-and-pier with cripple wall foundation failure, Ferndale, Calif.

Figure 17: Post-and-Pier Foundation

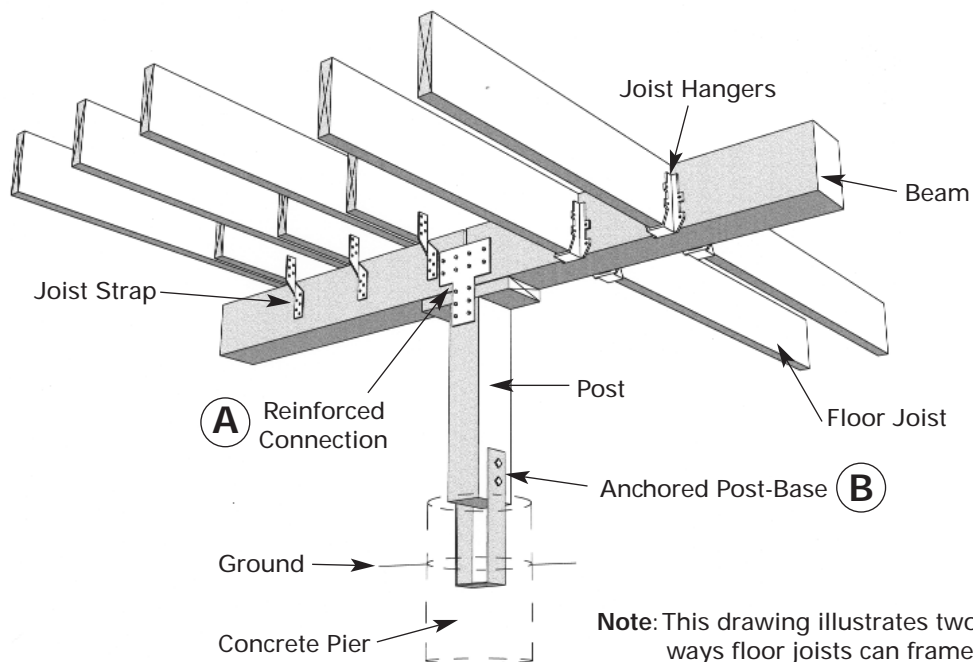

Note: This drawing illustrates two different ways floor joists can frame into a beam.



Steinbrugge Collection, EERC, UCB

Failure of wood frame dwelling. A post-and-pier foundation with a cripple wall, Kern County, Calif.

earthquake is to have the connection reinforced with steel plates or with plywood or OSB connectors. Pre-manufactured metal straps or fixtures are available at most hardware stores (“A” in **Figure 17**). This reinforcement is especially important if the joint in the beam falls on top of the post.

The other critical joint in this foundation lies between the post and the pier. Examine this area carefully. The post should be securely fastened to the pier, and all components should be well constructed, free of rust, severe cracks (anything wider than the edge of a dime) and rot. Most new construction will have the post attached to the block with a built-in metal fixture (“B” in **Figure 17**). In older construction, the post may simply rest on the top of the block. Reinforce the connection by nailing heavy-gauge straps onto at least two sides of the post and then bolting them into the concrete block.

Keep in mind that strong connections between the various components may not be enough - the earthquake’s movement may still knock the home off its foundation. That is why extra connections and lateral bracing may be necessary. If your home has an exterior cripple wall, bracing and anchoring it further can provide the necessary protection. Refer to the previous discussion on cripple wall foundations for inspection and retrofit techniques.

If your home does not have an exterior cripple wall, lateral bracing and strong connections between the posts are critical. Simple toe nailing is not sufficient. Since the seismic evaluation of post-and-pier foundations is complex, you should consult a professional engineer.



EERI, S. Swan EQE Inter.

Post-and-Pier Foundation; undamaged (top) and damaged (bottom), Costa Rica.

Floor Systems

An earthquake exposes the floor to substantial forces that can distort and damage the floor system, jeopardizing the strength of your home. The floor system typically consists of *floor joists*, *floor sheathing* and *band joists*, which are located along the floor's perimeter (Figure 18).

If you have access to the underside of your floor, make sure that your floor system is tied together and that the sub-floor is securely connected to the underlying floor joists. To reduce the possibility of rotation in an earthquake, each joist should be nailed to a band joist. *Blocking*

or bridging can also be placed between joists to keep them from falling over. The forces absorbed by the band joist or blocking must, in turn, be transferred to the foundation. Secure this connection by using metal ties or framing anchors. Finally, make sure you do not find any evidence of poor workmanship, rust or rot.

It may be difficult for you to access these areas. Often, the best time to evaluate your floor system is when you are planning to remodel. If your inspection reveals any problems, consult a professional engineer for the best way to retrofit your floor system.

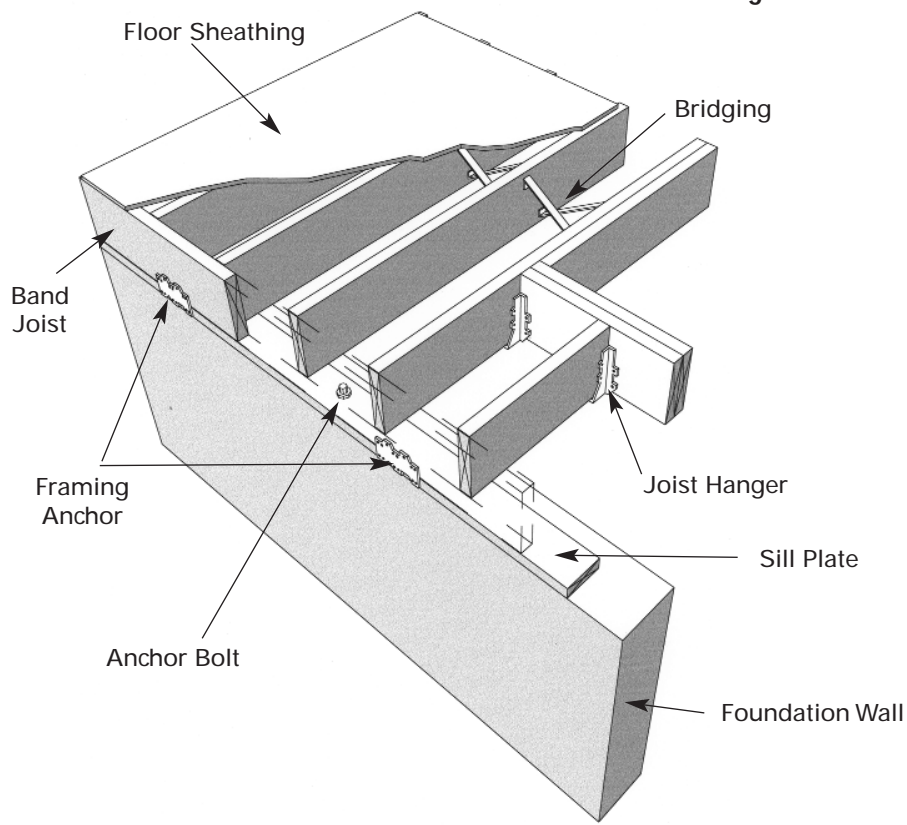

Figure 18: The Floor System



Steinbrugge Collection, EERC, UCB

Above: Failure of a wood stud wall to sill plate connection. Note anchor bolt and sill plate are still connected, San Fernando, Calif. Below, right: Failure of a unreinforced brick-veneer wall, San Fernando, Calif.

Wall Systems

During an earthquake, the walls in your home, especially the exterior walls, play an important role in preventing your home from collapsing. The walls along with the floors and roof create a box. As the ground shakes, the floors and roof sway back and forth, while the walls in between try to stop your home from moving too far. To do their job, your walls must be strong and securely tied to the roof, floor and foundation.

WOOD-FRAMED WALLS

Traditionally, the exterior walls of wood-frame houses are supported with wood studs attached to structural-grade plywood, oriented strand board (OSB) or diagonal wood

sheathing. To protect the exterior walls from the elements, they are covered with lap siding, stucco, stone or brick veneer. In order for this system to resist damage from earthquake forces, it must be well designed with the appropriate hardware in place to ensure a strong connection between all of the elements. See **Figure 13** on page 20 for details.

Also, consider the number, size and location of the windows and doors, including garage doors, in your home. Too many can weaken your walls and lead to possible collapse in an earthquake. Imagine a closed box with several openings: it will cave in much easier than one with no openings.

Unlike wood siding, brick and stone veneers require special attention because of their weight. During an earthquake, this heavy veneer can fall off, causing injury and significant damage. It is very important that these walls be *tied* to the wood-frames behind them with simple metal ties secured in the mortar. Sound building practices usually provide sufficient ties for the first story - even when not designed specifically for earthquakes. Special attention, however, may be required for the size and spacing of the ties in the upper stories.

Because it is difficult to access these areas, the best time to inspect is while you are remodeling or adding on to your home. If you have any concerns about your home's exterior walls, openings or veneer, contact a



Steinbrugge Collection, EERC, UCB

professional engineer. Ask him or her to determine how well your walls can withstand an earthquake and to recommend necessary retrofit measures.

UNREINFORCED MASONRY WALLS

If your home's walls are made entirely of brick, stone, clay tile, concrete block or adobe, they could be susceptible to earthquake damage. In newer masonry homes on the West Coast, these types of walls are often reinforced with steel bars grouted inside the walls. If the walls are reinforced and well anchored to the foundations, floors and roofs, they can usually withstand an earthquake. But masonry that is in poor condition, unreinforced or not securely tied to the rest of the structure, has the potential to collapse. **Figure 19** highlights the differences between reinforced and unreinforced concrete block masonry walls.

A proper retrofit generally requires anchorage designed specifically for earthquakes.



USGS, M. Hopper

Second floor wall failure in an unreinforced masonry home. Note the apparently undamaged two-story wood frame building on right, Coalinga, Calif.

Since evaluating structural masonry walls for general soundness and specific seismic features is quite complex, it would be best to consult a professional engineer.

Figure 19: Reinforced vs. Unreinforced Masonry Walls

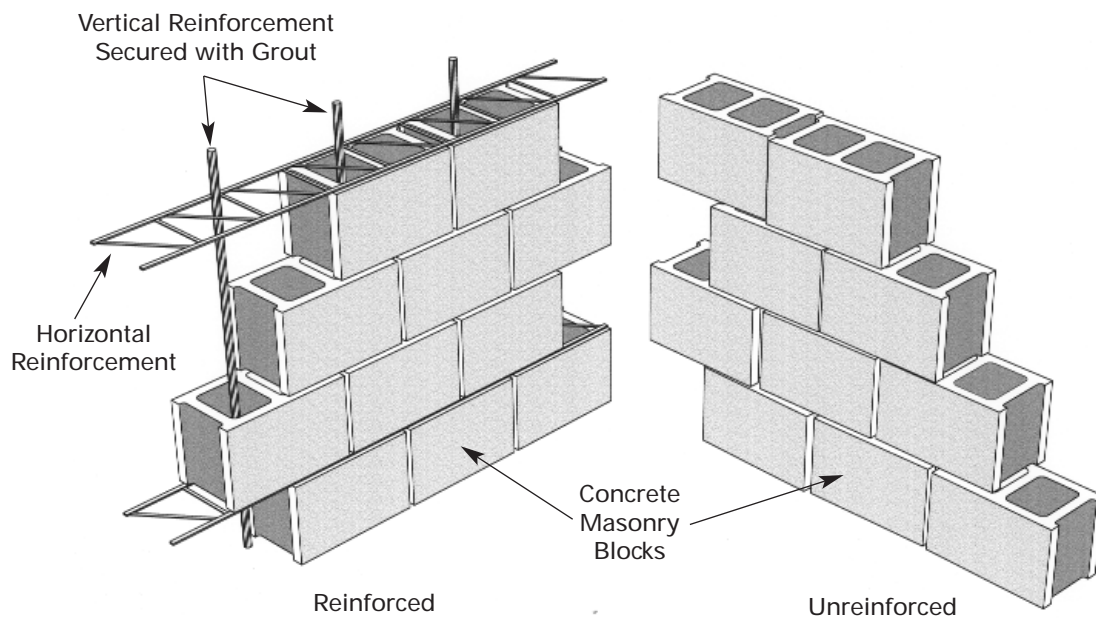

Roof Systems

For your home to adequately resist the force of an earthquake, your roof structure must function like the top of a box, keeping the walls tied together and preventing your home from coming apart at the seams. The typical roof system includes a *roof covering*, *roof sheathing* and supporting *roof frame*.

Start by inspecting your roof covering - it should be in good condition with no evidence of excessive wear and tear. Non-structural lightweight coverings, such as wood or asphalt shingles, usually behave well during an earthquake. Tile and slate coverings, which are heavy, tend to tax



Godden Collection, EERC, UCB



Stetnbrugge Collection, EERC, UCB

Top: Collapsed heavy tile roof supported on unreinforced brick masonry, San Fernando, Calif.
Bottom: Roof to wall failure on an industrial building, San Fernando, Calif.

your entire earthquake-resisting system and are also susceptible to sliding or falling off the roof during an earthquake.

Next, consider what lies under the roof covering - the roof sheathing. Both plywood and OSB roof sheathing give strength to the roof regardless of the roof style. Roofs fully sheathed with structural-grade plywood or OSB tend to provide the greatest stability to the overall structure.

Board sheathing is not as earthquake resistant as plywood and OSB sheathing, but may be adequate in smaller homes. Consult a professional engineer for more specific information. Also, keep in mind that large *dormers*, skylight openings and any other features that interrupt the sheathing can weaken your roof structure.

Remember: sheathing can only do so much. You must also consider the roof system's framing - the *trusses* or *rafters* that support the roof covering and sheathing. Similar to floor systems, roof-framing systems can rotate or fall over when your home starts to move in an earthquake. To prevent this, *blocking* can be placed between the rafters or trusses where they rest on the wall. See **Figure 20**. Be sure to nail the blocking to the roof sheathing in order to transfer the lateral loads into the wall. Metal strap connectors or properly placed toe-nailing ensure that the blocking is adequately connected to the wall and rafters.

You may not be able to thoroughly examine your roofing system due to limited access. The best time for a complete inspection is just before you re-roof your home. If you have any concerns about your roof's covering, sheathing, openings or framing members, talk to a professional engineer or qualified roofing contractor.

Unreinforced Chimneys

Unless specifically designed and reinforced for lateral forces, brick or stone chimneys often come apart or topple during an earthquake, causing serious damage and injury. Usually, only the top portion of the chimney breaks apart during an earthquake; however, in some cases the entire chimney peels away from the side of the home.



Steinbrugge Collection, EERC, UCB

Chimney damage, San Fernando, Calif.

Check the top of your chimney to be sure it is free of severe cracks (anything wider than the edge of a dime). Take a close look at the mortar between the bricks. It should not scrape away easily with a metal tool. Even if your chimney is in good condition, it may still be at risk, especially if it is tall and slender. Some chimneys have metal straps that hold them to the side of the home. Carefully inspect these fastenings. They should be in good condition with no evidence of poor workmanship or rust.

If you are uncertain about what you see, consult with a professional engineer. The engineer may recommend adding a brace between the top portion of the chimney and the roof. You may also need to use metal straps at several points to anchor the chimney to the home (**Figure 21**).

Figure 21: How to Reinforce a Chimney

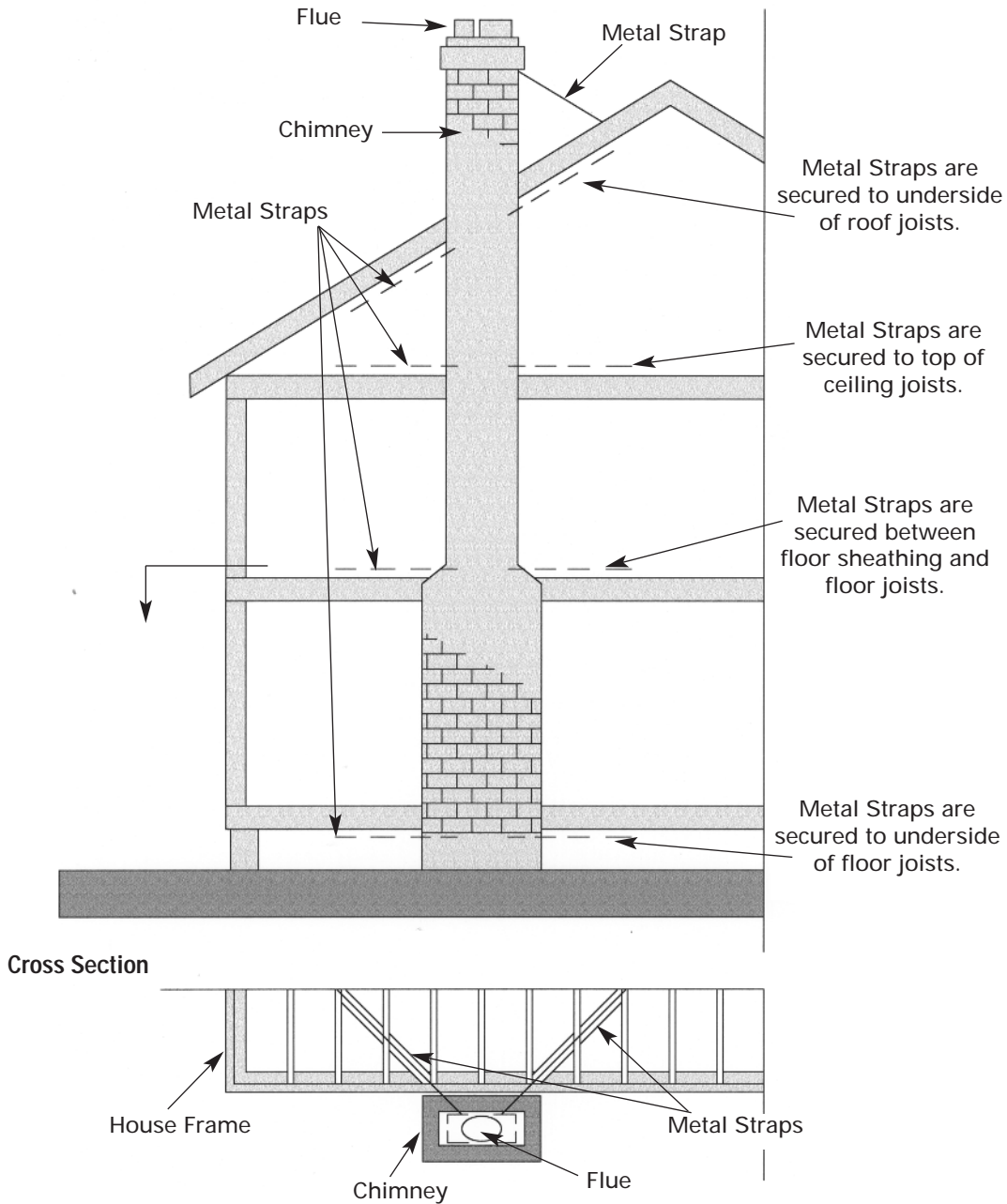

Note: (1) Wood blocking should be added to joists underneath metal straps.
(2) See FEMA-232 for specific details, referenced on pg. 37.

Garages

Garages are particularly vulnerable to earthquake damage. The situation becomes especially serious if the garage has a portion of the home over it. The large garage door opening removes almost an entire side of the box configuration and requires the remaining narrow walls on either side to support the roof and extra rooms. If these walls are not designed carefully to handle the situation, the entire structure may collapse when an earthquake strikes.

Strengthening the narrow garage walls generally requires engineering details, such as specially detailed plywood panels, steel bracing or a steel frame. A professional engineer can help you decide what will work best for your home.

Room Additions

If you've put on an addition or made other modifications in the past, you may have unknowingly weakened your home's earthquake resistance. Sometimes, homes that were originally very simple and structurally sound undergo changes that make them bigger or fancier, but also more prone to earthquake damage.

If you are planning to make major changes to the structure of your house, or if you suspect existing features lack good engineering details, consult a professional engineer.

Steinbrugge Collection, EERC, UCB



*U.S. Geological Survey
(D. Perkins)*

Top: Two stories now crushed to one story due to weak lower level (note crushed auto), San Fernando, Calif. Bottom: Damage due to inadequate lateral bracing on the ground level, San Francisco, Calif.

STRUCTURAL CHANGES THAT INCREASE THE RISK OF EARTHQUAKE DAMAGE INCLUDE:

- replacing large portions of walls with windows or glass doors;
- adding large skylights or additional stories;
- opening large portions of existing floors; or
- additions that create an "L" configuration.

home improvement project list

This list of home improvements divides the different retrofits into cost categories. The categories reflect the cost of each individual item. The cost will be slightly higher if you hire someone

to complete the work. You or your contractor can tackle these projects one at a time, but remember, the more you do the stronger your home becomes.



Category \$ (<\$300)

- Fasten bookcases and cabinets to nearby walls;
- Install latches on cabinet doors and drawers;
- Secure electronic equipment, artwork and other breakable items to the tops of bookcases and cabinets;
- Anchor large appliances to nearby walls;
- Secure pictures and bulletin boards to walls;
- Attach safety cables to light fixtures, suspended ceilings and other hanging items;
- Apply safety film to windows and doors;
- Secure water heater to nearby wall.



Category \$\$ (\$300-\$1000)

- Reinforce cripple wall;
- Strengthen narrow walls on either side of garage opening;
- Anchor unreinforced chimneys.



Category \$\$\$ (>\$1000)

- Add anchor bolts or steel plates to foundation;
- Secure post-and-pier foundation;
- Modify floor system;
- Strengthen wood-framed walls;
- Reinforce masonry walls;
- Retrofit roof system;
- Evaluate unique room additions.

before, during and after: be completely prepared

You will give yourself and your family a better chance of escaping harm during an earthquake by taking as many of the precautions outlined in this brochure as possible. But, these steps are only the beginning. To protect yourself as completely as possible, here are some added suggestions:

Before an Earthquake Strikes:

- Teach everyone to “duck” or drop to the floor, take “cover” under a desk or table and “hold” on to it when an earthquake strikes. Remember the phrase: “Duck, Cover and Hold.”
 - Learn first aid and CPR.
 - Put together an emergency kit that includes at least a three-day supply of drinking water and food that needs no refrigeration and, generally, no cooking; emergency cooking equipment, if required; a portable NOAA weather radio; first aid supplies and medications; basic tools, such as a wrench, a flashlight and gloves; portable lanterns and batteries; credit cards and cash; and important documents, including insurance policies.
 - Know where your gas, electric and water main shut-off controls are and how to turn them off if there is a leak or electrical short. Make sure all adult and teenage members of your family know how to shut off each utility.
- Become familiar with your community’s disaster preparedness plans and create a family plan. Know where the closest police, fire and emergency medical facilities are located.
 - Plan an escape route from your home and neighborhood and designate an emergency meeting place for the family to reunite. Establish a contact point to communicate with concerned relatives.
 - Periodically review your homeowner’s insurance policy with your insurance agent or company to make sure that, if you are the victim of a disaster, you have enough coverage to rebuild your home and life. The typical homeowner’s insurance policy does not include earthquake coverage. If you are in an earthquake-prone area, you should consider purchasing earthquake insurance.



EERI, J. Eagan



D. Perkins, USGS

During an Earthquake:

- If you are indoors, “duck, cover and hold” until the shaking stops. Do not try and run out of a building – you may be hit by falling debris.
- If you are outdoors, move quickly and safely into the open, away from electrical lines, trees and buildings, and wait for the shaking to stop.
- If you are driving, carefully and slowly bring your vehicle to a stop at the side of the road away from traffic. Make sure that you do not stop on or under bridges. Do not stop under power lines or near roadway signs that might fall. Once the shaking has stopped, you can continue driving. Watch carefully for possible damage to the roadway.

After an Earthquake Strikes:

- Check for hazards, such as gas or water leaks and electrical shorts. Turn off damaged utilities. Have the fire department or gas and electric companies turn the utilities back on when the area is secured.

- Check for injuries and administer first aid as needed.
- Check your food and water supplies. Do not eat anything from open containers near shattered glass.
- Listen to and follow the advice and recommendations of local aid organizations, including the emergency management office, the fire department and the utility companies.
- Keep roads and phone lines clear for emergency use.
- Be prepared for aftershocks.



C. Stover, USGS

references

APA: The Engineered Wood Association. Earthquake Safeguards. Tacoma, WA: APA, 1997.

Association for Bay Area Governments. Techniques for Mitigating Earthquake Hazards. 18 March 1999.
<<http://www.abag.ca.gov/bayarea/eqmaps/fixit/fixit.html>>

California Governor's Office of Emergency Services and Federal Emergency Management Agency. An Ounce of Prevention: Strengthening Your Wood-frame House for Earthquake Safety. Sacramento, CA: California OES, 1993.

California Governor's Office of Emergency Services and Federal Emergency Management Agency. Guide to Strengthening and Repairing Your Home Before the Next Earthquake. Sacramento, CA: California OES, 1995.

California Seismic Safety Commission. The Homeowner's Guide to Earthquake Safety. Sacramento, CA: California SSC, 1998.

Federal Emergency Management Agency. Reducing the Risks of Nonstructural Earthquake Damage. FEMA 74. Washington, DC: FEMA, 1994.

Federal Emergency Management Agency. Homebuilder's Guide to Seismic Resistant Construction. FEMA 232. Washington, DC: FEMA, 1998.

Federal Emergency Management Agency. Identification and Reduction of Nonstructural Earthquake Hazards in Schools. FEMA 241. Washington, DC: FEMA, 1993.

Federal Emergency Management Agency. FEMA: Mitigation "How To" Series.
<<http://www.fema.gov/MIT/how2.htm>>

Gray, Ralph Gareth. "Riding Out the Big One". Fine Homebuilding. Two Part Series: December 1990/January 1991.

Kimball, Virginia. Earthquake Ready: The Complete Preparedness Guide. Malibu, CA: Roundtable, 1992.

Mroz, M.P., and T.T. Soong. NIST GCR 97-732: Fire Hazards and Mitigation Measures Associated with Seismic Damage of Water Heaters. Gaithersburg, MD: National Institute of Standards and Technology, 1997.

Southern California Earthquake Center. Putting Down Roots in Earthquake Country. 1995.
<<http://www.scecdc.scec.org/eqcountry.html>>



additional sources of information



APA - The Engineered Wood Association

P.O. Box 11700
Tacoma, WA 98411-0700
Tel: 253-565-6600
Help Desk: 253-620-7400
Fax: 253-565-7265
<http://www.apawood.org/>

American Society of Civil Engineers (ASCE)

1801 Alexander Bell Drive
Reston, VA 20191-4400
Tel: 703-295-6000
Fax: 703-295-6222
<http://www.asce.org>

American Red Cross

Check your local phone directory for
the chapter nearest you.
<http://www.redcross.org>

Association of Bay Area Governments (ABAG)

P.O. Box 2050
Oakland, CA 94604-2050
Tel: 510-464-7900
Fax: 510-464-7970
<http://www.abag.ca.gov/>

Applied Technology Council (ATC)

555 Twin Dolphin Drive, Suite 550
Redwood City, CA 94065
Tel: 650-595-1542
Fax: 650-593-2320
<http://www.atcouncil.org/index.htm>

Building Officials and Code Administrators International, Inc. (BOCAI)

4051 West Flossmoor Road
Country Club Hills, IL 60478-5795
Tel: 708-799-2300
Fax: 708-799-4981
<http://www.bocai.org>

California Division Of Mines and Geology

801 K Street, MS 14-33
Sacramento, CA 95814-3532
Tel: 916-445-5716
Fax: 916-445-1853
<http://www.consrv.ca.gov/dmg>

California Office of Emergency Services

1300 Clay Street, Suite 408
Oakland, CA 94612
Tel: 510-286-0895
Fax: 510-286-3581
<http://www.oes.ca.gov/>

California Seismic Safety Commission

1755 Creekside Oaks Drive, Suite 100
Sacramento, CA 95833
Tel: 916-263-5506
Fax: 916-263-0594
<http://www.seismic.ca.gov>

California Universities for Research in Earthquake Engineering (CUREe)

1301 S. 46th Street
Richmond, CA 94804-4698
Tel: 510-231-9557
Fax: 510-231-5664
<http://www.curee.org>

Center for Earthquake Research and Information (CERI)

University of Memphis
Memphis, TN 38152
Tel: 901-678-2007
Fax: 901-678-4734
<http://www.ceri.memphis.edu/>

Central U.S. Earthquake Consortium (CUSEC)

2630 E. Holmes Road
Memphis, TN 38118
Tel: 901-544-3570
Fax: 901-544-0544
<http://www.cusec.org>

**Earthquake Engineering
Research Center (EERC)**
NISEE/EERC
1301 South 46th Street
Richmond, CA 94804-4698
Tel: 510-231-9403
Fax: 510-231-9461
<http://nisee.ce.berkeley.edu/>

**Earthquake Engineering
Research Institute (EERI)**
499 14th Street, Suite 320
Oakland, CA 94612-1934
Tel: 510-451-0905
Fax: 510-451-5411
<http://www.eeri.org/>

**Federal Emergency
Management Agency (FEMA)**
P.O. Box 2012
Jessup, MD 20794-2012
Tel: 1-800-480-2520
<http://www.fema.gov>

Institute for Business & Home Safety (IBHS)
4775 E. Fowler
Tampa, FL 33617
Tel: 1-866-657-4247
Fax: 813-286-9960
<http://www.ibhs.org>

International Code Council (ICC)
5203 Leesburg Pike
Falls Church, VA 22041
Tel: 703-931-4533
Fax: 703-379-1546
<http://www.intlcode.org>

**International Conference
of Building Officials (ICBO)**
5360 South Workman Mill Road
Whittier, CA 90601-2298
Tel: 562-699-0541
Fax: 562-692-3853
<http://www.icbo.org>

International Window Film Association
318-A Brown Street
P.O. Box 3871
Martinsville, VA 24115-3871
Tel: 540-666-4932
Fax: 540-666-4933
<http://www.iwfa.com>

Mid-America Earthquake Center
1241 Newmark Lab MC-250
205 N. Mathews
Urbana, IL 61801
Tel: 217-244-6302
Fax: 217-333-3821
<http://mae.ce.uiuc.edu>

**Multidisciplinary Center for
Earthquake Engineering Research (MCEER)**
MCEER/IS
State University of New York @ Buffalo
304 Capen Hall
Buffalo, NY 14260-2200
Tel: 716-645-3377
Fax: 716-645-3379
<http://mceer.buffalo.edu>

**National Information Service for
Earthquake Engineering/California Institute
for Technology (NISEE/CALTECH)**
1301 South 46th Street
Richmond, CA 94804-4698
Tel: (510) 231-9403
Fax: (510) 231-9461
<http://www.eerc.berkeley.edu>

**National Institute for
Urban Search and
Rescue (NI/USR)**
P.O. Box 90909
Santa Barbara, CA
93190
Tel: 800-767-9983
Fax: 805-966-6178
<http://www.niusr.org/>



**National Oceanic and Atmospheric Administration (NOAA),
National Geophysical Data Center (NGDC)**
325 Broadway
Boulder, CO 80303
Tel: 303-497-6826
Fax: 303-497-6513
<http://www.ngdc.noaa.gov/ngdc.html>

**Nature of the Northwest
Information Center**
800 NE Oregon Street, Suite 177
Portland, OR 97232
Tel: 503-872-2750
Fax: 503-731-4066
<http://naturenw.org>

**Pacific Earthquake Engineering
Research Center (PEER)**
Richmond Field Station
University of California, Berkeley
1301 S. 46th Street
Richmond, CA 94804-4698
Tel: 510-231-9554
Fax: 510-231-9471
<http://peer.berkeley.edu>

Simpson Strong Tie
4637 Chabot Dr., Suite 200
Pleasanton, CA 94588
Tel: 925/460-9912
Fax: 925/847-0694
<http://www.strongtie.com/index.htm>

**Southern Building Code
Congress International, Inc. (SBCCI)**
900 Montclair Road
Birmingham, AL 35213-1206
Tel: 205-591-1853
Fax: 205-591-0775
<http://www.sbcci.org>

**Southern California
Earthquake Center (SCEC)**
University of Southern
California
Los Angeles, CA 90089
Tel: 213-740-5843
Fax: 213-740-0011
<http://www.scec.org/>

**University of California Berkeley
Seismological Laboratory**
202 McCone Hall
Berkeley, CA 94720-4760
Tel: 510-642-3977
Fax: 510-643-5811
<http://www.seismo.berkeley.edu/seismo/>

**USGS National Earthquake Information
Center (NEIC)**
P.O. Box 25046 , Denver Federal Center
Denver, CO 80225
Tel: 303-273-8500
<http://gldss7.cr.usgs.gov> or
<http://www.neic.cr.usgs.gov/>





checklist

How well will your home resist damage during a 3.0 earthquake? How about one that is a 6.0 or greater? Most homes typically will need some type of reinforcement to withstand a major earthquake. Here is a checklist that will help you focus on how to strengthen your home.

To answer some of these questions you may need to enter uncomfortable or small spaces. You may want to have an experienced inspector or professional engineer or architect check your home, instead. Whatever choice you make, take some time to do this before the next earthquake strikes.

Observation

Recommendation

Page

Unsecured bookcases and cabinets	Fasten to nearby walls	7
Cabinet doors and drawers that swing open easily	Install latches	10
Electronic equipment and artwork that can topple	Secure items to bookcases and cabinets	11
Pictures and bulletin boards that can fall	Fasten securely to walls	12
Hanging fixtures and suspended ceilings	Attach safety cables	13
Large appliances that can tip over	Anchor to nearby walls	15
Unprotected windows and doors	Apply safety film	15
Water heater that can tip over	Secure to nearby wall	16
Home not anchored to foundation	Add anchor bolts or steel plates	21
Weak cripple wall	Reinforce cripple wall	23
Unsound post-and-pier foundation	Secure post-and-pier foundation	25
Weak floor system	Modify floor system	27
Inadequate walls	Strengthen wood-framed walls	28
Unreinforced masonry	Reinforce masonry walls	29
Poor roof support	Retrofit roof system	30
Unsecured chimney	Anchor unreinforced chimney	31
Room over garage	Strengthen the support	33
Unique addition	Have engineer evaluate	33



I N S T I T U T E F O R
Business &
Home Safety®

4775 E. Fowler Ave. • Tampa, FL 33617
1(866) 657-4247 (IBHS) • Fax: (813) 286-9960 • www.ibhs.org
